

*International specialized medium for agricultural mechanization in developing countries*

ISSN 0084-5841

# AMA

**AGRICULTURAL MECHANIZATION IN ASIA, AFRICA AND LATIN AMERICA**

VOL.46, No.3, SUMMER 2015

A M A - AGRICULTURAL MECHANIZATION IN ASIA, AFRICA AND LATIN AMERICA

VOL.46, NO.3, SUMMER 2015

**FARM MACHINERY INDUSTRIAL RESEARCH CORP.**

**MITSUBISHI**

# MITSUBISHI TRACTOR



# MT28/MT36

*Sensitivity that has been continuously built.*

**NEW**

Mitsubishi Compact Tractor  
cover all aspects of Ground and Lawn care



**MITSUBISHI AGRICULTURAL MACHINERY CO., LTD.**

2-133-4, Sakurada, Kuki, Saitama, 340-0203 Japan  
<http://www.mam.co.jp>

*International specialized medium for agricultural mechanization in developing countries*

ISSN 0084-5841

# AMA

**AGRICULTURAL MECHANIZATION IN ASIA, AFRICA AND LATIN AMERICA**

VOL.46, No.3, SUMMER 2015

---

*Edited by*

YOSHISUKE KISHIDA

*Published quarterly by*

Farm Machinery Industrial Research Corp.

*in cooperation with*

The Shin-Norinsha Co., Ltd.

and

The International Farm Mechanization Research Service

TOKYO

**- AFRICA -**

Kayombo, Benedict (Botswana)  
Fonteh, Fru Mathias (Cameroon)  
Abdallah, Said Elshahat (Egypt)  
El Behery, A. A. K. (Egypt)  
Bani, Richard Jinks (Ghana)  
Djokoto, Israel Kofi (Ghana)  
Some, D. Kimutaiarap (Kenya)  
Houmy, Karim (Morocco)  
Adeniyi, O. O. (Nigeria)  
Bindir, Umar B. (Nigeria)  
Igbeka, Joseph C. (Nigeria)  
Odigboh, E. U. (Nigeria)  
Oni, Kayode C. (Nigeria)  
Opara, U. L. (South Africa)  
Kuyembah, N. G. (Sierra Leone)  
Abdoun, Abdien Hassan (Sudan)  
Saeed, Amir Bakheit (Sudan)  
Khatibu, Abdissalam I. (Tanzania)  
Tembo, Solomon (Zimbabwe)

**- AMERICAS -**

Cetrangolo, Hugo Alfredo (Argentina)  
Näas, Irenilza de Alencar (Brazil)  
Ghaly, Abdelkader E. (Canada)  
Hetz, Edmundo J. (Chile)  
Roudergue, Marco Antonio Lopez (Chile)  
Aguirre, Roberto (Colombia)  
Ulloa-Torres, Omar (Costa Rica)  
Magana, S. G. Campos (Mexico)  
Ortiz-Laurel, H. (Mexico)  
Bora, C. Ganesh (U.S.A.)  
Chancellor, William J. (U.S.A.)  
Goyal, Megh Raj (U.S.A.)  
Mahapatra, Ajit K. (U.S.A.)  
Nath, Surya (U.S.A.)

**- ASIA and OCEANIA -**

Farouk, Shah M. (Bangladesh)  
Hussain, Daulat (Bangladesh)  
Mazed, M. A. (Bangladesh)  
Wangchen, Chetem (Bhutan)  
Basunia, M. A. (Brunei)  
Shujun, Li (China)  
Illangantileke, S. G. (India)  
Ilyas, S. M. (India)  
Mani Indra (India)

Mehta C. R. (India)  
Michael, A. M. (India)  
Ojha, T. P. (India)  
Pathak, B. S. (India)  
Salokhe, Vilas M. (India)  
Singh, Gajendra (India)  
Verma, S. R. (India)  
Abdullah, Kamaruddin (Indonesia)  
Behroozi-Lar, Mansoor (Iran)  
Minaei, Saeid (Iran)  
Abdul-Munaim, Ali Mazin (Iraq)  
Snobar, Bassam A. (Jordan)  
Chung, Chang Joo (Korea)  
Lee, Chul Choo (Korea)  
Bardaie, Muhamad Zohadie (Malaysia)  
Pariyar, Madan P. (Nepal)  
Jayasuriya, Hemanatha P. W. (Oman)  
Chaudhry, Allah Ditta (Pakistan)  
Khan, Alamgir A. (Pakistan)  
Mughal, A. Q. A. (Pakistan)  
Rehman, Rafiq ur (Pakistan)  
Abu-Khalaf, Nawaf A. (Palestine)  
Lantin, Reynaldo M. (Philippines)  
Venturina, Ricardo P. (Philippines)  
Al-suhaibani, Saleh Abdulrahman (Saudi Arabia)  
Al-Amri, Ali Mufarreh Saleh (Saudi Arabia)  
Chang, Sen-Fuh (Taiwan)  
Peng, Tieng-song (Taiwan)  
Krishnasreni, Suraweth (Thailand)  
Phongsupasamit, Surin (Thailand)  
Senanarong, Akkapol (Thailand)  
Pinar, Yunus (Turkey)  
Haffar, Imad (United Arab Emirates)  
Hay, Nguyen (Viet Nam)  
Lang, Pham Van (Viet Nam)

**- EUROPE -**

Katardjiev, Tihomir Hristov (Bulgaria)  
Kic, Pavel (Czech)  
Müller, Joachim (Germany)  
Gasparertto, Ettore (Italy)  
Hoogmoed, W. B. (Netherlands)  
Pawlak, Jan (Poland)  
Marchenko, Oleg S. (Russia)  
Martinov, Milan (Serbia)  
Jaime, Ortiz-Cañavate (Spain)  
Sims, Brain G. (U.K.)

**EDITORIAL STAFF**

(Tel.+81-(0)3-3291-3674)

Yoshisuke Kishida, Chief Editor  
Masako Terauchi, Managing Editor  
R. Lal Kushwaha, Editorial Consultant

**ADVERTISING**

(Tel.+81-(0)3-3291-3674)

Yuki Komori, Manager (Head Office)  
Advertising Rate: 300 thousand yen per page

**CIRCULATION**

(Tel.+81-(0)3-3291-3674)

(Fax.+81-(0)3-3291-5717)

Editorial, Advertising and Circulation Headquarters  
1-12-3, Kanda Nishikicho, Chiyoda-ku, Tokyo 101-0054, Japan

URL: <http://www.shin-norin.co.jp/english/>

E-Mail: [ama@shin-norin.co.jp](mailto:ama@shin-norin.co.jp)

Copyright © 2015 by

FARM MACHINERY INDUSTRIAL RESEARCH CORP.

in SHIN-NORINSHA Co., Ltd

Printed in Japan

## EDITORIAL

The population of the farmers who are engaged in agriculture in the world still accounts for the half of the whole world population. World population has exceeded 7.2 billion and is predicted to reach 9 billion in 2030. In future, most of the population growth will happen in urban areas. In every country, younger people tend to move to the city to look for the job other than agriculture since agriculture has small profit and demands continuous attention.

The phenomenon such as aging of farmers and reduction of young people in rural area has been seen in many countries. Japan is on the top of the phenomenon and average age of farmers has exceeded 66 years. Aging of farmers is advancing rapidly and at the same time, the agricultural labor force is rapidly decreasing. I live in rural area and the person who lives in front of my house is engaging in agriculture and his age is 76. In Japan, many farmers over 80 are engaged in agriculture using agricultural machine and it is no exaggeration to say that the senior citizens and agricultural machine are supporting Japanese agriculture. With the increasing population, the world is seeking more food production. Aging of the farmers who support the food production and the labor shortage are becoming a huge problem. To solve it, development of agricultural mechanization that matches each country's agricultural conditions is necessary.

The need for agricultural mechanization is becoming more and more important not only for improving agricultural labor productivity but also for increasing land productivity.

However the keyword "Agricultural Machinery" has become less visible in many universities of Japan and other advanced countries. In Japan, there were 23 Universities with departments of Agricultural Machinery or Agricultural Engineering before, but we cannot see any of those names now.

The time is coming to review drastically the education system for agricultural machinery at educational institutions. There are many problems that cannot be solved by the power of industry; however, it is necessary for the public research institutions to re-approach the agricultural machinery research and human resource development.

Since 1971, AMA has been published in order to stimulate communication among the world-wide experts for promoting agricultural mechanization in developing countries. My objective through AMA has been in backing up the development of agricultural mechanization of the world as an important media toward the better future.

By researching, developing and spreading appropriate agricultural machineries for the farmers in developing countries, economic disparities that are spread worldwide will be reduced and peaceful world will be realized. Let's all come together for it.

**Yoshisuke Kishida**  
Chief Editor

July, 2015

# CONTENTS

## AGRICULTURAL MECHANIZATION IN ASIA, AFRICA AND LATIN AMERICA

Vol.46, No.3, Summer 2015

Yoshisuke Kishida	5	Editorial
D. M. S. P. Bandara R. M. R. N. K. P. Rathnayake T. M. R. Dissanayake	7	Performance Evaluation of Different Types of Spice Grinding Machinery for Producing Chili Powder
Gurvinder Singh, J. S. Mahal G. S. Manes, Apoorv Prakash Anoop Dixit	13	Effect of Blade Shape and Speed of Rotary Puddler on Puddling Quality in Sandy Clay Loam Soil
O. T. Bahnas, A. E. Khater	19	Effect of Soil Preparation with Organic Fertilization on Soil Characteristics and Performance of Rice Mechanical Drilling
M. O. Marenaya	25	Characterising the Performance of a Deep Tilling Down-Cut Rotavator Fitted with L-Shaped Blades
Tarl Berry, Mulugeta A. Delele Henk Griessel Umezuruike Linus Opara	34	Geometric Design Characterisation of Ventilated Multi-scale Packaging Used in the South African Pome Fruit Industry
Nur-A-Alam, Rostom Ali Murshed Alam	43	Nondestructive Approach to Evaluate Defects in Elements of Agricultural Machinery
S. K. Chaudhary, T. K. Bhattacharya V. B. Shambhu	53	Parametric Standardization of Catalyst Removal from Transesterified Palm Oil Through Wash Water
Said Elshahat Abdallah Wael Mohamed Elmessery	57	Kitchen Bio-Wastes Management by Vermicomposting Technology
V. I. Umogbai	72	Development of a Mechanical Family Poultry Feeder
C. N. Bezuidenhout, P. Langlois	80	Performance Evaluation Analyses of Commercial Sugarcane Mechanical Harvesting Contractor Operations
Nitesh, Y. K. Yadav	87	Design and Development of a Desiccant Integrated Solar Dryer
	56	ABSTRACTS

	★	
Book .....	12	
News.....	18, 86	
New Co-operating Editor.....	24	
Event Calendar .....	71	

	★	
Co-operating Editor .....	91	
Back Issues.....	95	
Instructions to AMA Contributors .....	97	

# Performance Evaluation of Different Types of Spice Grinding Machinery for Producing Chili Powder



by  
D. M. S. P. Bandara  
Mechanical Engineer,  
Srimapriyangika@yahoo.com

R. M. R. N. K. P. Rathnayake  
Research Officer,

T. M. R. Dissanayake  
Mechanical Engineer,

Research & Development Centre, Institute of Post Harvest Technology, Jayanthi Mawatha, Anuradhapura, SRI LANKA

## Abstract

A study was conducted to evaluate the performance of two types spice grinding machines currently used in Sri Lanka namely pin (disk) mill and plate mill. The machines were evaluated for their performance in chili grinding with a view to recommending the suitable machine or machinery combination for the Sri Lankan spice processing industry. Their performance were evaluated in terms of particle size obtained after grinding; color of ground chili; pungency level after grinding; fat content, moisture content, and fiber content of ground chili and energy consumption per kilogram of processing chili powder.

The pin mill performed best as a single machine in terms of particle size of ground product among two types of spice processing machinery. However, the machinery combination of plate mill gave color close to the red line from orange line.

The machinery combination of one pass through pin mill and other two passes through plate mill produced a particle size of 500  $\mu\text{m}$ . Color of the ground chili powder was closer to the redness from or-

ange which reveals by the lightness value ( $L^*$ ) of 36.50. The fat content, moisture content, fiber content of ground chili powder were 14.9 %, 9.9 % and 27.1 % respectively and all these parameters comply with SLSI specification. The energy consumption per kilogram of chili powder was 0.095 kWh. This combination was the best combination for producing chili powder as the consumers' acceptance and therefore the market price.

## Introduction

The processing and trade of spices has always been an important industry. The spice trade still has a significant impact on the economy of many countries such as Grenada, Sri Lanka and Indonesia. Spices are used in the preparation of food for more of reasons such as enhancing the flavor and aroma of food, adding piquancy and pungency and improving appearance by adding color to food. These spices are also used in the medicines because of their carminative stimulating and digestive properties. Small scale processing of spices can also be economically

and socially successful (Schweiggert *et al.*, 2007).

The manufacturing process involves cleaning, drying, grinding or pulverizing, sieving and packing of spices such as chili, pepper, turmeric, coriander, etc either individually or in combination with other spices.

To improve the quality of the spice products there are few parameters to draw attention from harvesting stage to grinding stage. It is not possible to produce a good spice product from low quality harvested material. The main obstacle to correct harvesting is the crop being picked immature. This is usually due to fear of theft or the farmer requiring money urgently. However, every effort should be made to wait until the spices are fully mature ([www.indianindustry.com](http://www.indianindustry.com) visited on 02. 10. 2006).

The crop should be cleaned before processing. The first stage is to remove dust and dirt. Next step is the drying. This is by far the most important section in the process. The inability to adequately dry the produce will slow down the whole process and possibly lead to mould growth or discoloration. For spice processing there are many mod-



ern equipment available in world's trade.

Grinding adds value but must be done carefully as there are difficulties. A whole, intact product can be easily assessed for quality whereas a ground product is more difficult. There is a market resistance to ground produce due to fear of adulteration. This can only be overcome by producing a consistently high quality product and gaining the confidence of customers.

Most spices are subjected to particle size reduction, because only few of them can directly be incorporated into food products. Different types of grinding equipment, for example plate mill or pin (disk) mill or both are established in the spice industry in Sri Lanka. Furthermore hammer mills are also used today in medium and large scale industry. Plate mills have been specially introduced to meet the demands for cheaper production. The mechanism is simple in design, easy operation and fine finish.

Pin (Disk) mill consists of rotating disk, attached to the main shaft and fixed casing. As the material is fed into the machine through the hopper, which regulates the feed into the processing chamber, it gets sheared between pins attached to the rotating disk and fixed casing. The perforated screen fitted in the periphery of the processing chamber regulates the fines of sheared material depending upon its hole diameter.

Hammer mill is suitable for medium/large scale to fine grinding of soft to medium hard materials. The desired fineness is being achieved by the type of Hammer, the rotor speed, size of screen opening and this can be varied according to market requirements. The final output product is then collected from the cyclone separator for bagging

and the excess air is filtered through cotton dust bags. This machine facilitates to grinding chilly, coriander, turmeric, etc (Panday *et al.*, 2006).

In this study, the attention was drawn to evaluate the grinding machinery performance on dry chili grinding. Chili is an important spice and condiment in the tropics and subtropics. It is an indispensable item in the kitchen for everyday cooking in Sri Lanka.

Even though the quality standards have been formulated for chili grinding (Annon, 1988) no previous work has been done to compare the efficiency of different chili grinding machines available in the market. Ad-hoc evaluation of individual machinery has been done previously. However a comparative study on performance of different types of available machines has not been done.

## Methodology

### Selection of Grinding Machine and Their Combinations

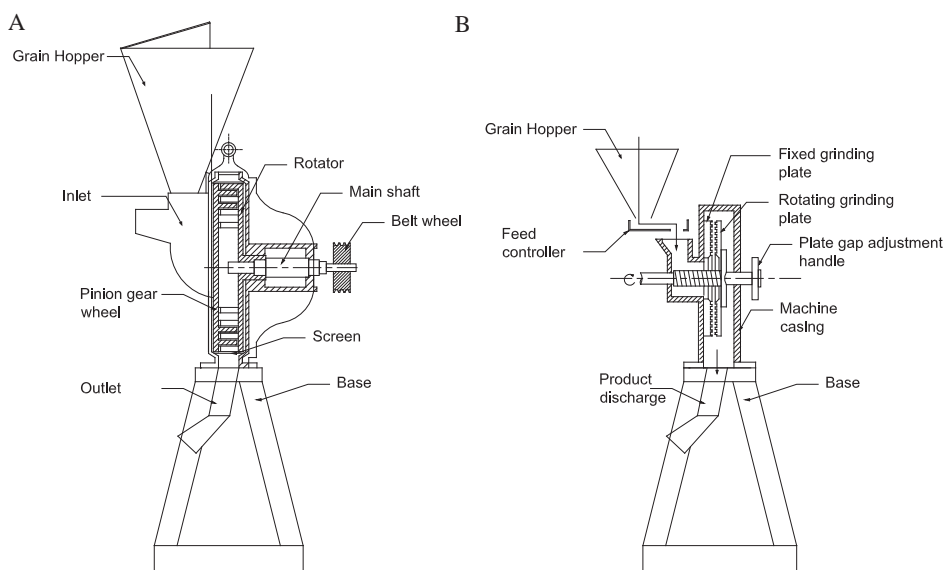
There are three types of chili grinding machines commonly available in the Sri Lankan market.

Small and medium scale spice processors are widely using plate mill and pin mill (Fig. 4) which are the most popular and simple grinding mills in Sri Lankan spice processing industry. Hence, these two types were selected for evaluation of performance. As the Hammer mill is suitable for larger scale production; it is not been considered for this experiment.

There are four types of pin mills and three types plate mills according to the capacity. In this study, the machine which consists of rotating disk having diameter of 0.23 m and 4 kW single phase motor was selected for the experiment. The plate mill which consists of 0.18 m diameter iron grooved plate was selected for the experiment. This was run by a single phase 1.5 kW motor. These two types were obtained from Udaya Industries, Weligalle and installed at Institute of Post Harvest Technology, Anuradhapura, Sri Lanka. Component drawing of the pin mill and plate mill is shown in Fig. 1.

Testing was carried out to evaluate the performance of each machine and machine combinations. The machine combinations consisted of a maximum of two machines

Fig. 1 Component diagram, A:Pin mill, B: Plate mill





**Table 1** Machinery Combinations

Treatment No	Machinery Combination
T <sub>1</sub>	M <sub>1</sub>
T <sub>2</sub>	M <sub>2</sub>
T <sub>3</sub>	M <sub>1</sub> M <sub>1</sub>
T <sub>4</sub>	M <sub>2</sub> M <sub>2</sub>
T <sub>5</sub>	M <sub>1</sub> M <sub>2</sub>
T <sub>6</sub>	M <sub>2</sub> M <sub>1</sub>
T <sub>7</sub>	M <sub>2</sub> M <sub>2</sub> M <sub>2</sub>
T <sub>8</sub>	M <sub>1</sub> M <sub>1</sub> M <sub>1</sub>
T <sub>9</sub>	M <sub>1</sub> M <sub>2</sub> M <sub>2</sub>
T <sub>10</sub>	M <sub>1</sub> M <sub>1</sub> M <sub>2</sub>
T <sub>11</sub>	M <sub>2</sub> M <sub>1</sub> M <sub>1</sub>
T <sub>12</sub>	M <sub>2</sub> M <sub>2</sub> M <sub>1</sub>

M<sub>1</sub>: Pin mill, M<sub>2</sub>: Plate mill

in order to ensure that a reasonable initial capital cost is maintained in establishing a processing line. The number of passes through a single machine or a machine combination was varied from one to three in order to maintain operational cost at a reasonable level. A total of 12 treatments, comprising of two machine types and their combinations with one, two and three passes, were used for the evaluation. Each treatment was replicated three times (**Table 1**).

### Samples Preparation

A homogeneous bulk sample of dried Chilies of medium type, belonging to the popular Sri Lankan variety MI-2, was used for the experiment. The selection criterion of MI-2 was based on the popularity (**Fig. 2**).

The initial moisture content of chili taken for milling was around at  $14 \pm 0.5\%$ .

Discolored pods and foreign matters were removed from samples prior to roasting. Chili products are prepared by roasting of the raw material as a whole.

Temperature of the raw material goes to 70-80 °C; the most of volatile substances evaporate. The product becomes very inferior without any cause (<http://practicalaction.org> visited on 19. 03. 2008). The color is close to black from red. On the other hand, the lower is the roasting temperature, harder for grinding. Therefore, it is suitable to select optimum temperature using grinding ability and microbial growth. Hence, the samples were roasted for one hour at 60 °C temperature. The initial moisture content of chili taken for grinding was kept constant at 12 or 14 (as given above the **Fig. 2**)  $\pm 0.5\%$  using an oven dryer.

### Experimental Procedure

A trial run was carried out before each test run using a similar quantity of dry chilies that was to be used in the experiment. This allowed for the proper adjustments of processing units to obtain optimum capacity with required quality.

For each test run, one kilogram of dry chilies was used. During the test runs, the following observations were recorded.

1. Current drawn by the machine was measured by using an analog type Clip-On Ampere meter (KYORITSU, Model: 2608A) of accuracy  $\pm 0.1$  A.
2. Temperature increase of powder was measured using a digital thermometer (HANNA, Model: HI

145-20) of accuracy  $\pm 0.1$  °C.

3. Recovery of powder was taken by measuring difference between input chili and ground chili using Digital Balance (ZHUNSHENG SCALES Model: 250).
4. Time taken for each run at each combination was measured by using Digital stop watch.

Representative powder samples from each treatment were analyzed in the laboratory for particle size distribution, moisture content, fat content, fiber content and color.

The particle size distribution was measured using particle size analyzer (OCTAGON, Model: Digital) having six sieves of aperture size 850, 500, 300, 250, 212 and 125 microns and the samples of 100 g were weighed into the nearest 0.01 g and sieving was carried out for 10 min with occasional tapping on the set of sieves. The material retained on the sieve was transferred quantitatively into a tare dish and weighed.

If the ground chili particle passed through a sieve of a 500 micron with the minimum of 90 % by mass chili it shall be sufficiently ground (Annon, 1988)

It is unable to use the oven dry method to calculate the moisture content of chili powder, because when heating chili more than 120 °C, volatile compounds will be removed. Hence Dean and Stark apparatus was used. In a Dean and Stark method, representative chili sample (50 g) was mixed with 100 ml of toluene in 500 ml glassware. The heating of the mixture was carried out above boiling temperature for six hours. Extracted moisture volume on toluene layer was measured using measuring cylinders. Then moisture content was calculated by using following equation (Panday *et al.*, 2006).

$$Mc = [(Wv \times Dw) / Sw] \times 100. (1)$$

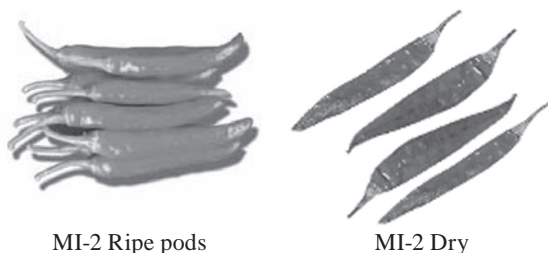
Where,

Mc: Moisture content

Wv: Water volume

Dw: Density of water

Sw: Sample weight

**Fig. 2** MI-2 Chili variety

The color of the ground chilies was determined in five replicates using a Chroma meter (Konica Minolta, Model CR-400). Representative chili powder samples (50 g) were introduced to the Chroma meter and readings of L\*a\*b values were taken. Preliminary experiments revealed that a\* and b\* values of the ground chili were not significantly different in each machinery combination, where the lightness value (L\*) contributed much to the difference in colour. Hence L\* value was taken into consideration in further experiments.

Moisture content, crude fat and crude fiber of chili powder were determined in triplicate according to the standard methods of AOAC (Horwitz, 2000).

Determination of non volatile ether extracts for every sample was also determined in triplicate according to the standard methods of SLSI (Annon, 1988).

The energy consumption of processing per kilogram of chili powder was calculated by considering power consumed by the relevant machinery or machinery combination. The electric current used by the machine during the grinding operation was measured by clip-on ampere meter (KYORITSU, Model 2608A). It was assumed that line voltage was 230 V and consumed power by the machine was calculated using following Equation (Singh, 2003).

$$P = VI \dots\dots\dots (2)$$

Where;

P: Power

V: Voltage

I: Ampere

The energy consumption of processing per kilogram of chili powder was calculated by considering power consumption. The following assumptions were taken into consideration when computing the energy consumption: total time of grinding as the sum of processing time and handling time of each passes taken for the determination of machinery

capacity and kWh, recovery of chili powder taken as the average of out-turn, number of working hours per day as eight hours; number of working days per year as three hundred days, machinery are working in their full capacity.

### Statistical Analysis

The experimental structure of all the experiments was complete randomized design. Data gathered were analyzed using Analysis of Variance (ANOVA) by Statistical Analysis System (Annon, 2000). Percentage data were transformed to arc sin values prior to analysis. Differences between treatment means were obtained by Duncan's multiple range test at 5 % significance level (p < 0.05). The subjective measurements of sensory evaluation were analyzed by Friedman test using the MINITAB statistical package.

## Results and Discussion

### Particle Size Analysis

The particle size distribution varied with different machine combinations and the number of passes through the machines. Four machinery combinations out of the twelve combinations produced chili powder of particle size less than 500 micron which is the requirement of Sri Lanka standard (Annon, 1988) for ground chili (Table 2).

The necessary particle size distribution of 500 µm comply with the SLSI standards, These were obtained from the following combinations of three passes through plate mill (T<sub>7</sub>); three passes through pin mill (T<sub>8</sub>); one pass through pin mill and two pass through plate mill (T<sub>9</sub>), single passes through plate mill and two passes through pin mill (T<sub>11</sub>).

At any combination of disk mill, first pass should be without a screen and at the multiple passes it should be with 500 micron (0.5 mm) screens.

### Analysis of Color Value of Ground Chili

The tristimulus L\* a\* b\* measurements relate to the human eye response to color, and has uniform visual spacing. The L\* variable is a lightness value which ranges between 0 for black and 100 for white. Thus, when the L value reaches near to zero the redness increased and the value near to hundred it reaches to orange color. The color of chili powder plays an important role in marketing because increasing redness maximizes the customer satisfaction. However, according to the SLSI standards (Annon, 1988) color of the chili powder could be varied in between orange to red. Results of the study revealed that three passes through plate mill gives the highest value of redness (Table 3) that was proved by the appearance of the four samples (Fig. 3).

In this connection, plate mill implies the more red color of ground sample than that of combination of disk mill whereas, the disk mill performs best as a single machine for obtaining finer particle size of ground product (Table 2).

**Table 2** Particle size distribution of ground chili

Treatment No.	Particle Size Average*/µm	Material Retaining on 500 µm Sieve (%)
T <sub>1</sub>	> 600	-
T <sub>2</sub>	> 600	-
T <sub>3</sub>	> 600	-
T <sub>4</sub>	> 600	-
T <sub>5</sub>	> 600	-
T <sub>6</sub>	> 600	-
T <sub>7</sub>	500	0.8
T <sub>8</sub>	500	0.6
T <sub>9</sub>	500	9.5
T <sub>10</sub>	> 600	-
T <sub>11</sub>	500	0.7
T <sub>12</sub>	> 600	-

At any combination of disk mill, first pass should be without a screen and at the multiple passes it should be with 500 micron (0.5 mm) screens.

### Moisture Content of Ground Chili

The moisture content of ground chili powder varied with the ma-

chinery and the number of passes through the machines. The lowest moisture content of 8.2 % was ob-

served in the combination of three passes through pin mill (T<sub>7</sub>) while the highest moisture content of 10.5 % was observed in combination of single pass through pin mill and two passes through plate mill (T<sub>9</sub>) (Table 4).

**Table 3** Color value of ground chili distribution

Treatment No.	Machinery combination	L Value
T <sub>7</sub>	M <sub>2</sub> M <sub>2</sub> M <sub>2</sub>	35.55 <sup>d*</sup>
T <sub>8</sub>	M <sub>1</sub> M <sub>1</sub> M <sub>1</sub>	39.65 <sup>c</sup>
T <sub>9</sub>	M <sub>1</sub> M <sub>2</sub> M <sub>2</sub>	36.50 <sup>a</sup>
T <sub>11</sub>	M <sub>2</sub> M <sub>1</sub> M <sub>1</sub>	37.02 <sup>b</sup>

**Table 5** Fiber content of ground chili

Treatment No.	Machinery combination	Fiber Content (%)
T <sub>7</sub>	M <sub>2</sub> M <sub>2</sub> M <sub>2</sub>	27.6 <sup>a</sup>
T <sub>8</sub>	M <sub>1</sub> M <sub>1</sub> M <sub>1</sub>	27.4 <sup>a</sup>
T <sub>9</sub>	M <sub>1</sub> M <sub>2</sub> M <sub>2</sub>	27.1 <sup>b</sup>
T <sub>11</sub>	M <sub>2</sub> M <sub>1</sub> M <sub>1</sub>	27.0 <sup>b</sup>

**Table 4** Moisture content of ground chili

Treatment No.	Machinery combination	Moisture Content (%)
T <sub>7</sub>	M <sub>2</sub> M <sub>2</sub> M <sub>2</sub>	9.9 <sup>b</sup>
T <sub>8</sub>	M <sub>1</sub> M <sub>1</sub> M <sub>1</sub>	8.2 <sup>c</sup>
T <sub>9</sub>	M <sub>1</sub> M <sub>2</sub> M <sub>2</sub>	9.9 <sup>b</sup>
T <sub>11</sub>	M <sub>2</sub> M <sub>1</sub> M <sub>1</sub>	10.7 <sup>a</sup>

**Table 6** Fat content of ground chili

Treatment No.	Machinery combination	Fat Content (%)
T <sub>7</sub>	M <sub>2</sub> M <sub>2</sub> M <sub>2</sub>	14.5 <sup>a</sup>
T <sub>8</sub>	M <sub>1</sub> M <sub>1</sub> M <sub>1</sub>	14.6 <sup>a</sup>
T <sub>9</sub>	M <sub>1</sub> M <sub>2</sub> M <sub>2</sub>	14.9 <sup>a</sup>
T <sub>11</sub>	M <sub>2</sub> M <sub>1</sub> M <sub>1</sub>	14.3 <sup>a</sup>

**Fig. 7** Energy consumption of processing per kilogramas of chili powder

Treatment No.	Machinery combination	Energy consumption/kg (kWh)
T <sub>7</sub>	M <sub>2</sub> M <sub>2</sub> M <sub>2</sub>	0.100 <sup>a</sup>
T <sub>8</sub>	M <sub>1</sub> M <sub>1</sub> M <sub>1</sub>	0.095 <sup>b</sup>
T <sub>9</sub>	M <sub>1</sub> M <sub>2</sub> M <sub>2</sub>	0.095 <sup>b</sup>
T <sub>11</sub>	M <sub>2</sub> M <sub>1</sub> M <sub>1</sub>	0.090 <sup>c</sup>

Any two means in the same column followed by different letters differ significantly according to Duncan's multiple range test (P < 0.05).

An important aspect in determining the shelf-life of flour is whether it has been milled dry, moist or wet. The milled product must then be dried before storage. The recommended moisture content for safe storage of chili powder is less than 13 % (Annon, 1988). This is partly accomplished by the heat from the drying process, milling process and on mats where a thin layer is exposed to the sun (Modi *et al.*, 2006).

### Analysis of Fiber Content of Ground Chili

SLSI standards for ground chilies emphasize the need of having fiber content not more than 28 %. All the treatments have shown the almost similar results (Table 5) relevant to fiber content which complies with SLSI standard (Annon, 1988).

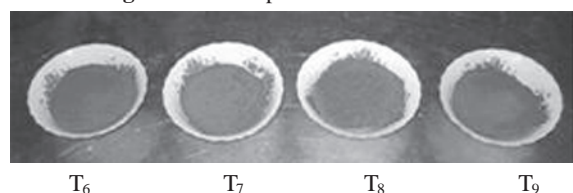
### Fat Content of Ground Chili

There is no significant difference among the treatments relevant to fat content.

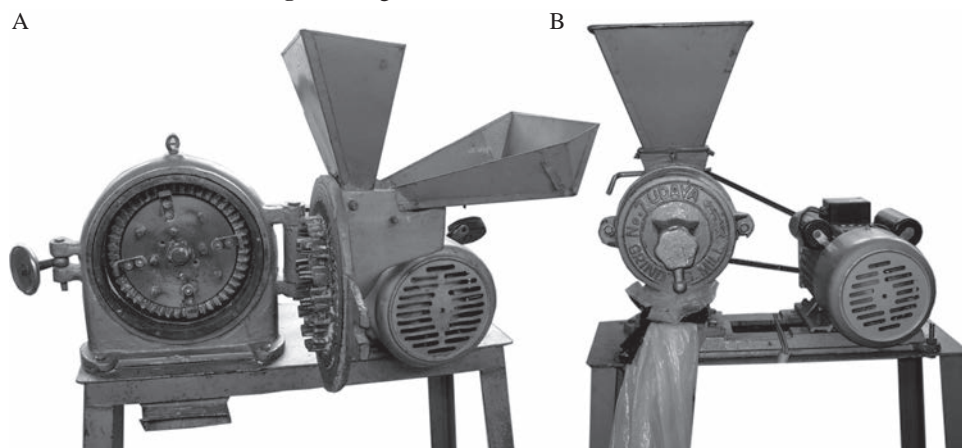
### Energy Consumption

The lowest energy consumption per kilogram of processing (Table 7) chili was obtained from single pass through plate mill; double passes through pin mill whereas the highest reading recorded from three passes through plate mill. In other two combinations; three passes through pin mill and single passes through pin mill with two passes through plate mill the energy consumption values imply that difference is not insignificant (a).

**Fig. 3** Chili samples of four treatments



**Fig. 4** Two grinders; A: Pin mill, B: Plate mill



## Conclusions

The color, pungency and particle size distribution are considered to define the quality of dried chili powder as these properties reflect the consumers' acceptance and therefore the market price. The pin mill performed best as a single machine in terms of particle size of ground product among two types of spice processing machinery. However, combination of plate mill gives color close to the red line from orange line.

The machinery combination of one pass through pin mill without the screen and other two passes through plate mill ( $T_9$ ) is the best combination for producing chili powder. This combination produces a particle size of 500  $\mu\text{m}$ . The Lightness value ( $L^*$ ) is 36.50. The fat content, moisture content, fiber content of ground chili powder are 14.9 %,

9.9 % and 27.1 % respectively and all these parameters comply with SLSI specifications. The energy consumption per kilogram of chili powder in this combination is 0.095 kWh.

## REFERENCE

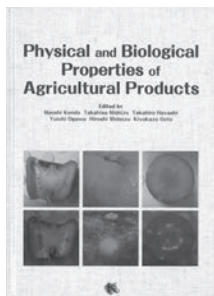
- Annon. 1988. Sri Lanka Standard: 117. Speciation for ground chili, 1988 and 186 Test for Spices and condiments, 1973.
- Annon. 2000. SAS Institute Inc., SAS User's Guide: Statistics. SAS Institute Inc. Cary, NC, 2000
- Horwitz, W. 2000. Official Method of Analysis of AOAC International, Vol. II, Suite 500 481, Maryland 20877-2417. USA.
- Modi V. K, G. S. S. Gauda, P. Z. Sakhare, N. S. Mahendrakar, and N. D. Rao. 2006. Pre-processed spice mix and changes in its quality during storage, Journal of Swiss Society of Food science and Technology, Elsevier Ltd, Vol 39, pp 613-629.
- Pandey H., H. K. Sharma, R. C. Chauhan, B. C. Sarkar, and M. B. Bera. 2006. "Experiment in Food processing Engineering", CBS Publishers & Distributors- New Delhi, p 157-167.
- Schweiggert, U., R. Carle, and A. Schieber. 2007. Conventional and Alternative Process for Spice Production -review, Trends in Food Science, p 260-268.
- Retrieved from <http://www.indian-industry.com>. Visited, 2nd October 2006.
- Retrieved from <http://practicalaction.org> Visited, 19th March 2008.
- Singh, S. 2003. Electric Engineering Drawing. part II. S. K. Kataria and sons, p 156/

■ ■

## Books

### Physical and Biological Properties of Agricultural Products

Edited by: Naoshi Kondo, Takahisa Nishizu, Takahiro Hayashi, Yuichi Ogawa, Hiroshi Shimizu, and Kiyokazu Goto



The books contain many kinds of properties of complicated and diversified agricultural products with important theories and illuminating data, which are fundamental to the design of agricultural machinery, facilities and sensing systems.

#### Contents

Physical Properties of Agricultural Products/ Structural Characteristics Related to Physical Properties/ Fundamental Physical Properties/ Thermal Properties Mechanical Properties/ Acoustic and Vibrational Properties/ Electric Characteristics/ Optical Properties/ Biochemical Property

#### Distributors

International Specialized Book Services (ISBS) [orders@isbs.com](mailto:orders@isbs.com)

■ ■



# Effect of Blade Shape and Speed of Rotary Puddler on Puddling Quality in Sandy Clay Loam Soil



by  
Gurvinder Singh  
Ex-M. Tech. Student,



J. S. Mahal  
Additional Director  
Research Farm Machinery & Bio-Energy



G. S. Manes  
Sr. Research Engineer -cum- Head,



Apoorv Prakash  
Research Fellow,



Anoop Dixit  
Research Engineer,

Department of Farm Machinery & Power Engineering PAU Ludhiana, INDIA

## Abstract

A study was undertaken to evaluate the performance of different rotary blade shapes for puddling under sandy clay loam soils commonly used in the Punjab state of India. In order to find out the best combination of blade shapes and rotary speed of the puddler, experiments were conducted by using three blade shapes (J, C and L) at three rotor speeds (245, 263 and 280) in sandy clay loam soil (Clay 21.4 %, Silt 15.5 % and Sand 63.1 %). The effect of blade shape and rotor speed was expressed in terms of puddling index, infiltration rate, PTO power requirement and fuel consumption. Different treatment combinations were compared with the control (Puddling with cultivator  $\times$  2 + Planker  $\times$  1). The action of the J shaped blade resulted in the maximum puddling index (73.78 %) and minimum infiltration rate (0.01 mm/h) at 280 rpm rotor speed as compared to the C and L: shaped blades as well as

the control. J: shaped blade required minimum PTO power (19.10 kW) and consumed minimum fuel (16.40 l/ha) at 245 rpm rotor speed as compared to C and L: shaped blades as well as the control. J: shaped blades deposited maximum clay content (28.27 %) and minimum sand content (54.03 %) at top 10 mm layer of soil. The action of J: shaped blade at rotor speed of 280 rpm exhibited better results for puddling index, infiltration rate, PTO power requirement and fuel consumption as compared to C and L: shaped blades as well as the control.

**Key words:** Puddling index, infiltration rate, rotavator, rotavator blades and rotor speed.

## Introduction

Paddy is grown in an area of 45.5374 million ha in India with 99.182 million tons of annual production (Anon, 2013). Paddy cultivation requires higher energy input

particularly for seed bed preparation and irrigation. As per prevailing practice, shallow standing water in the field during early months of crop growth is a pre-requisite. This practice leads to considerable loss of water through deep percolation. Paddy is grown in both uplands and lowlands. Fields are flooded with irrigation water. Under flooded conditions, the problem of water percolation loss is overcome by different tillage practices. A common practice includes compaction of sub-surface by puddling. This leads to breaking of soil aggregates into finer soil particles at saturation near soil moisture condition (Sharma and De Datta, 1986). Puddling is carried out under flooded conditions with standing water on the surface. Different tillage practices have been used for decreasing percolation losses (Aggarwal *et al.*, 1995). Puddling is an ideal method to reduce water percolation. However, unless used properly it might have an adverse effect on

soil physical properties, growth and yield of succeeding crops (Boparai *et al.*, 1992). Puddling in standing water before transplanting paddy seedlings is a common practice to reduce water infiltration. It facilitates transplanting and helps to maintain standing water in the field by controlling infiltration losses. Thus, it helps to conserve water, the most precious natural resource. The seedlings can be easily transplanted in the soft puddle with less resistance and damage. Different methods and implements have been used to achieve the required degree of puddling. Some of these include a country-plough, disc harrow, tine cultivator and angular puddler. Reduced draft requirements help in reducing wheel slippage under wet conditions for better power utilization. Rotary tools reduce the draft and time required for puddling operations and help in improving the quality of puddling (Triplett, 1986). Many studies on puddling by using a rotavator have been conducted. However, the data on the effect of blade shape and rotor speed for given soil condition on puddling

quality is lacking. The present study was undertaken to understand the relationship of blade shape, rotor speed and soil type with the puddling quality.

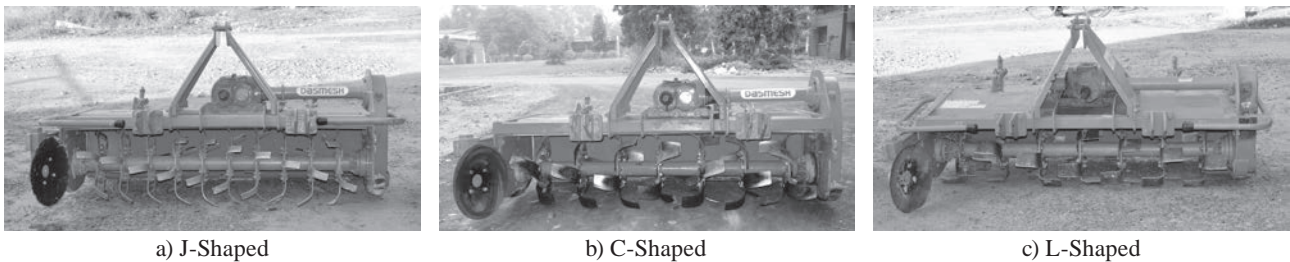
### Materials and Methods

Field studies for evaluating the effect of blade shape and speed on puddling quality were conducted at The Research Farms of The Department of Farm Machinery and Power Engineering, Punjab Agricultural University, Ludhiana. The study was conducted on Sandy Clay Loam Soil (Clay: 10.2 %, silt: 17.2 %, sand: 72.6 %). A chisel plough was used to break the hard pan of soil, followed by tilling with a spring tyne cultivator twice and one planking operation. After preparatory tillage, leveling of the field was done by a Laser Land Leveller. Before start of field experiment the field was flooded with water to ensure complete soil saturation. During the experiment the water level in plots was maintained at 100 mm depth. Thereafter, puddling was carried

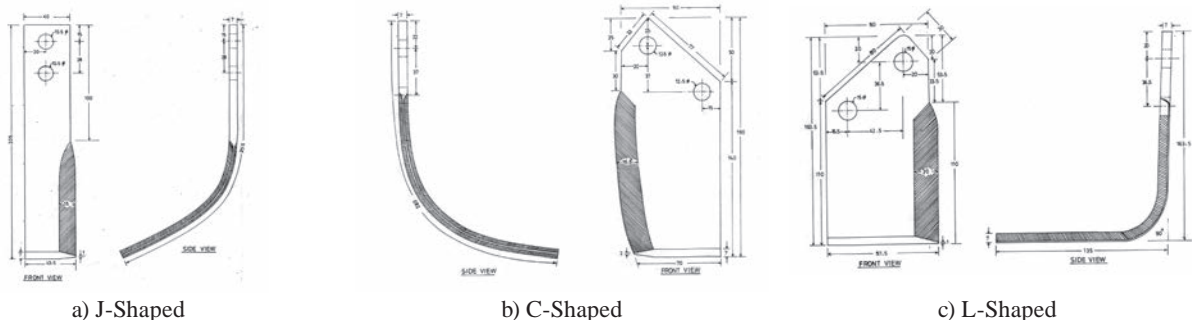
out by using J, C and L type rotary blades mounted on rotor shaft of the rotavator of 1.7 m width (**Fig. 1**). The detailed drawing of different type of blades is shown in **Figs. 2**. There were 10 flanges in J: shaped blade rotor and 7 flanges each in other two types (C & L shape) rotor comprising of 6 blade per flange. Rotavator was operated at constant depth (90 + 5 mm) by a 55hp tractor at rotor speed of 245, 263 and 285 rpm respectively in three experimental plots for each blade shape. Control treatment comprised two passes of cultivator (1.7 m) followed by single pass of planker.

The effect of dependent parameters viz. puddling index (PI), infiltration rate (IR), power requirement (PR) and fuel consumption (FC) was observed. Puddling index was measured as per IS 11531:1985. Infiltration rate was calculated taking in account rainfall and evaporation in intervals till a steady state (basic infiltration rate) was achieved. PTO power was measured using strain gauge type torque transducer and fuel consumption using fuel flow meter. Different parameters were

**Fig. 1** View of Rotavator with different type of blades



**Fig. 2** Front and side view of different type of rotavator blades





computed as follows and shown in Fig. 3:

**Puddling Index**

$$PI = (V_s / V_t) \times 100$$

Where,

PI = Puddling Index,

$V_t$  = total volume of soil-water suspension in the test tube and

$V_s$  = volume of soil settled in the test tube.

**Infiltration Rate**

$$IR = (RF + FD - E) / t$$

Where,

IR = Infiltration (mm),

RF = Rainfall (mm),

FD = Fall in water depth (mm),

E = Evaporation (mm) and

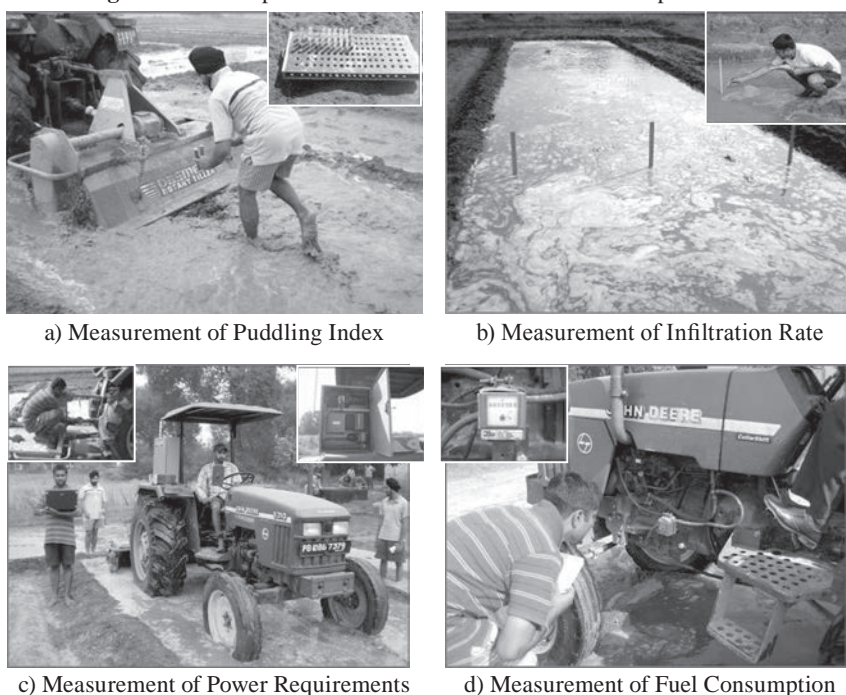
t = time interval (h) for measuring period.

Infiltration rate was measured in the plots for number of days till a steady state (basic infiltration rate) was achieved.

Different parameters were ana-

lyzed on the basis of Randomized Block Design (RBD) test using software "SAS 9.2 Version at 5 % level of significance. The soil samples were taken from three depths i.e. 0-10 mm, 11-40 mm and 41-90 mm respectively from different plots at end of each experiment. The collected samples were used for determining sand, silt and clay contents at different depths by International Pipette method (Gee and Bauder 1986).

Fig. 3 View of experiments and measurements of various parameters



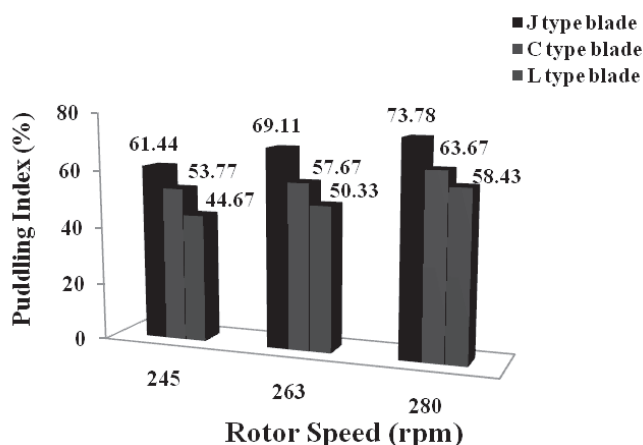
a) Measurement of Puddling Index

b) Measurement of Infiltration Rate

c) Measurement of Power Requirements

d) Measurement of Fuel Consumption

Fig. 4 Puddling index (%) for different blade shape at different rotor speed



**Results & Discussion**

**Effect Of Operational Parameters On Puddling Index**

For a given rotor speed of rotavator, the puddling index was significantly higher in case of J: shaped blades followed by C and L: type blades as well as the control respectively (Fig. 4). It is attributed to better churning of soil in standing water owing to higher number of blades on the rotor. The lowest puddling index was observed for control treatment (33.00 %). This is attributed to lack of effective soil churning (manipulation) by the cultivator used as control (Singh and Dhaliwal, 1995).

The puddling index also increased significantly with the increase in the rotor speed for all three shapes of blades. The higher puddling index (73.78 %) was observed for J: shaped blade at 280 rpm rotor speed and lowest for L: shaped blade at 245 rpm (44.67 %). This is due to the fact that as the rotor speed was increased, the bite length of soil cut by rotavator blades decreased this resulting in better puddling of soil.

The interaction between J: shaped blade at rotor speed of 245 rpm (61.44 %) and C: shaped blade at rotor speed of 280 rpm and the interaction between C: shaped blade at rotor speed of 263 rpm (57.67 %) and L: shaped blade at rotor speed of 280 rpm (58.43 %) was non-significant. The same puddling index

**Table 1** Infiltration rate at different time intervals

Time (Hours after puddling)	Rotor speed (rpm)									Control Treatment
	245			263			280			
	Blade shape									
	J	C	L	J	C	L	J	C	L	
5	1.70	3.82	4.20	1.30	2.80	2.90	0.78	2.04	2.50	5.79
29	0.18	1.12	2.20	0.09	1.01	1.79	0.06	0.68	1.11	3.98
53	0.07	0.45	0.91	0.04	0.46	0.68	0.01	0.24	0.42	2.91
77	0.06	0.12	0.38	0.03	0.09	0.27	0.01	0.06	0.16	1.79
101		0.10	0.19		0.07	0.12		0.04	0.07	1.52
125			0.18			0.11			0.06	1.24
149										1.22

was observed for both treatments. All other interactions between the given blades shape (J, C and L) and rotor speeds (245 rpm, 263 rpm and 280 rpm) were found to be significant at 5 % level of significance.

**Effect of Operational Parameters on Infiltration Rate in Sandy Clay Loam Soil**

As evident from the data presented in **Table 1**, for each interval of measurement the infiltration rate was minimum for J: shaped blades followed by C: shaped and L: shaped blades at each rotor speed. Infiltration rate was found to be the maximum for control treatment for each interval of measurement.

Basic infiltration rate was achieved after 77 h, 101 h, 125 h and 149 h for J: shaped blade, C: shaped blade, L: shaped blade and for control treatment respectively.

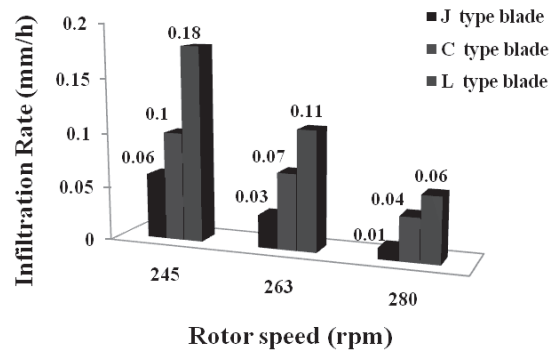
At a given rotor speed, the infiltration rate was significantly lower in case of J: shaped blades followed by C and L: shaped blades as well as control respectively (**Fig. 5**). It is attributed to higher puddling index achieved with J: shaped blade as compared to C, L and control treatment. The higher Puddling index resulted in decreased infiltration rate (Singh and Dhaliwal 1995). Control treatment resulted in the maximum infiltration rate (1.22 mm/h) due, mainly to, less clay particles resting at the top layer of soil as compared to the soil churned by rotavator blades.

The infiltration rate also decreased significantly with increase in the rotor speed for all shapes of blades. This was due to better puddling index for higher speeds. The higher infiltration rate (0.18 mm/h) was observed for L: shaped blades at 245 rpm and lowest for J: shaped blade at 280 rpm (0.01 mm/h).

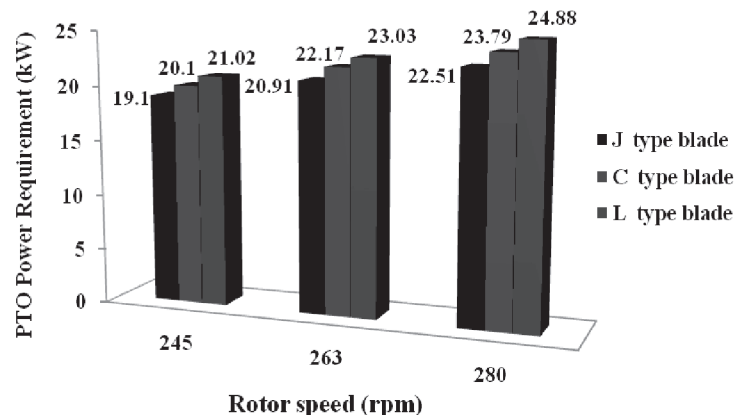
**Effect of Operational Parameters on Pto Power Requirement**

The power requirement at PTO was significantly higher in case of L: shaped blade followed by C and J for a given rotor speed of rotavator (**Fig. 6**). It was attributed to the fact that L: shaped blades cut the soil slices almost entirely along the cycloid and one of the lateral planes along the full depth of the blade. The C: shaped blades partly cut and partly tore the soil slices along the cycloid; but the slice of soil was cut off entirely along all its lateral planes of varying depths. Therefore, in C: shaped blades cutting, the lateral planes of varying depths were engaged instead of the entire depth of the lateral plane in L: shaped blades (Sharda and Singh, 2001). Whereas, in case of J: shaped blades, there was lesser area of con-

**Fig. 5** Effect of blade shape and rotor speed on infiltration rate (mm/h)



**Fig. 6** PTO power requirement (kW) for different blade shape at different rotor speed



**Table 2** Percentage of Clay, Silt and Sand at different depths of puddled soil

Composition (%)	Blade Shape: J		
	0-10 mm depth	10-40 mm depth	40-90 mm depth
Clay	28.27	25.37	24.43
Silt	17.70	18.33	18.40
Sand	54.03	56.43	57.17
	Blade Shape: C		
	0-10 mm depth	10-40 mm depth	40-90 mm depth
Clay	25.13	24.13	23.27
Silt	18.47	18.53	18.47
Sand	56.37	57.3	58.27
	Blade Shape: L		
	0-10 mm depth	10-40 mm depth	40-90 mm depth
Clay	24.33	23.17	22.37
Silt	18.47	18.07	17.23
Sand	57.23	58.77	60.20

tact with the soil.

The power requirement at PTO also increased significantly with increase in the rotor speed for all shapes of blades. The higher power requirement (24.88 kW) was observed for L: shaped blades at 280 rpm and lowest for J: shaped blades at 245 rpm (19.10 kW). This was due to the fact that increased rotor speed resulted in greater acceleration of soil particles and more number of cuts, thus offering higher resistance per unit time.

The interaction between J – shaped blade at 263 rpm rotor speed (20.91 kW) and L: shaped blades at 245 rpm rotor speed (21.02 kW); the interaction between J: shaped blades at 280 rpm rotor speed (22.51 kW) and C: shaped blades at 263 rpm rotor speed (22.17 kW) was not significant. It means both treatments

required same power at the PTO. All other interactions vary significantly at 5 % level of significance.

#### Effect of Operational Parameters on Fuel Consumption

At a given rotor speed of rotavator, fuel consumption was significantly lower in case of J: shaped blades followed by C and L: shaped blades as well as the control (**Fig. 7**). Overall control treatment consumed more fuel (22.12 L/ha) as compared to rotavator because of more number of operations (Cultivator 2 + Planker). Among the blades, J: shaped blades consumed the minimum fuel as compared to the other two types of blades which is supported by less PTO power requirement.

The fuel consumption also increased significantly with increase

in the rotor speed for all shapes of blades. The higher fuel consumption (19.61 L/ha) was observed for L: shaped blades at 280 rpm and lowest for J: shaped blade at 245 rpm (16.35 L/ha). This was due to the fact that with increased rotor speed, higher power was required at PTO.

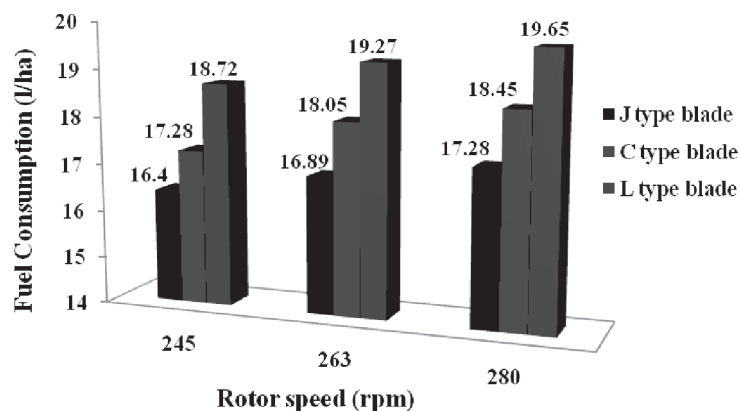
The interaction between J: shaped blades at rotor speed of 280 rpm (17.28 L/ha) and C: shaped blade at rotor speed of 245 rpm (17.28 L/ha) was non-significant. It means in these two treatments the fuel consumed was the same. All other interactions between three blade shapes (J, C and L) and three rotor speeds (245 rpm, 263 rpm and 280 rpm) were significant at 5 % level of significance.

#### Effect of Operational Parameters on Texture of Soil

The data for percentage of clay, silt and sand at 0-10 mm, 10-40 mm and 40-90 mm average depth of puddled soil for J, C and L: shaped blades is presented in **Table 2**. It shows that J: shaped blade of rotavator resulted in maximum average clay content followed by C: shaped blades and L: shaped blades in top 0-10 mm layer.

#### Optimum Operational Parameters

The optimum operational parameters for this study were determined on the basis of quality of puddling i.e., higher puddling index and lower infiltration rate. Rotavator with J – shaped blade at 280 rpm rotor speed resulted in higher puddling index (73.78 %), lower infiltration rate (0.05 mm/h), lower power requirement (22.51 kW) and lower fuel consumption (17.28 L/ha) as compared to C and L: shaped blades. Hence, J: shaped blades, with rotor speed of 280 rpm are found to be the optimum operational parameters to get the best quality of puddled soil.

**Fig. 7** Fuel consumption (l/ha) for different blade shape at different rotor speed

## Conclusions

Based on this study the following conclusions are drawn:

1. Puddling index was higher in case of J: shaped blades as compared to other two blades shape namely C & L: shaped. Puddling index increased with the increase in rotor speed.
2. Infiltration rate, PTO power requirement and Fuel consumption were lower in case of J: shaped blades as compared to other two blade shapes. Infiltration rate decreased with increase in rotor speed whereas PTO power requirement and fuel consumption increased with increase in rotor speed.
3. J: shaped blades at 280 rpm is considered as ideal for the puddling operation.

## REFERENCES

- Anonymous. 2013. [www.mospi.nic.in/Mospi\\_New/site/India\\_Statistics.aspx](http://www.mospi.nic.in/Mospi_New/site/India_Statistics.aspx). Official web site of The Ministry of Statistics and Programme Implementation. Site visited on 17 Jan 2013.
- Anonymous. 1985. IS:11531. Test code for puddler. Bureau of Indian Standards (BIS), New Delhi.
- Aggarwal, G. C., A. S. Sidhu, N. K. Sekhon, K. S. Sandhu, and H. S. Sur. 1995. Puddling and N management effects on crop response in a rice-wheat cropping system. *J Soil Tillage Res* 36: 129-39.
- Boparai, B. S., Y. Singh, and B. D. Sharma. 1992. Effect of green manuring with *sesbania aculeata* on physical properties of soil and on growth of wheat in rice-wheat and maize-wheat cropping systems in a semi-arid region of India. *Arid Soil Res Rehabilitation* 6: 135-43.
- Gee, G. W. and J. W. Bauder. 1986. Particle size analysis. In *Methods of Soil Analysis. Part I*. Klute (ed) Agronomy No. 9. Am Soc Agron Madison, USA. Pp 383-411.
- Sharma, P. K. and S. K. De Datta. 1985. Puddling influence on soil, rice development and yield. *Soil Sci Soc Am J* 49: 1451-57.
- Singh, G. and I. S. Dhaliwal. 1995. Performance evaluation of rotary tiller and cultivator as puddling equipment. Project Report Submitted to Department of Farm Machinery and Power Engineering, Punjab Agricultural University, Ludhiana, India BT-323.
- Sharda, A. and S. Singh. 2001. Influence of Selected Parameters on Performance of Rotary Tillers under Different Field Conditions. M.tech Thesis. Punjab Agricultural University, Ludhiana, India MT-88.
- Triplett, G. B. and M. A. Sprague. 1986. No-tillage and surface tillage agriculture-The tillage revolution. *Soil Tillage Res* 2: 21-25. ■■

---

## News

---

### Obituary



Dr. Jun Sakai, Professor Emeritus, Department of Agriculture, Kyushu University has passed away on June 8, 2015 at the age of 83. He had served as a co-operating editor of AMA from Japan from 1976 to 2015. He was born in Saga, Kyushu in 1931. During his long time career of agricultural engineering profession, he actively supported the development of agricultural mechanization in Asian countries as well as educated young students in universities. He authored the book entitled "Two-Wheel Tractor Engineering for Asian Wet Land Farming" which is widely read among researchers and farmers in Asia.



Dr. Graeme R. Quick, a co-operating editor of AMA from Australia since 1995, has passed away on May 19th after suffering sudden heart attack on May 18th. He was born in Melbourne, Australia in 1936. He had been Head, Agricultural Engineering Division, International Rice Research Institute (IRRI) from 1988 to 1995. Backed by considerable experience and enthusiasm he authored many books for agricultural engineering experts. The book "The Grain Harvesters" published from American Society of Agricultural Engineering in 1978 is very popular and read worldwide.

We give sincerest condolence to both of the co-editors and deeply appreciate their contribution to AMA.



# Effect of Soil Preparation with Organic Fertilization on Soil Characteristics and Performance of Rice Mechanical Drilling

by  
O. T. Bahnas  
Head Researcher,

A. E. Khater  
Researcher,

Agricultural Engineering Research Institute (AENRI), Giza, EGYPT

## Abstract

A study was carried out at Kalabsho Region, El-Dakhliya Governorate, during 2012 summer season to identify the effect of organic fertilization on rice mechanical drilling, soil characteristics and total yield. Sugar beet tops were used as an organic fertilizer. They were broadcasted upon the soil surface and tilled using a rotary plough. The experimental work was designed statistically as a split plots with three replications. The main plots involved the organic fertilization treatment with rotary ploughing (2 contrary passes), rotary ploughing (1 pass) and without rotary ploughing. The sub plots included seed drill with forward speed treatment levels of 2.25, 3.60, 4.95 and 6.30 km/h. The results indicated the following:

1. The seed drill at forward speed of 6.30 km/h after rotary ploughing (2 passes) achieved higher field capacity of 2.13 fed/h and lower specific energy of 1.21 MJ/fed.
2. The rotary ploughing (2 passes) achieved the best desirable soil characteristics of 1.28 g/cm<sup>3</sup> bulk

density, 18.11 mm/h infiltration rate, 2.14 dS/m salinity, 6.00 pH and 27.00, 18.20 and 347.00 ppm of the available N, P and K concentration, respectively.

3. The rotary ploughing (2 passes) achieved higher plant uniformity coefficient of 93 % and higher rice grain yield of 4.40 Mg/fed.

Generally, it is recommended to apply the chisel plough and rotary ploughing (2 passes) for sugar beet top mixing as an organic fertilization method of soil to achieve higher rice grain yield.

## Introduction

The excessive and continuous chemical fertilization causes an accumulated side effects on the human and the animal health and the environment and maximizes the agricultural production cost.

In Egypt, the agricultural policy paid a great attention to overcome or minimize chemical fertilizers application. This native goal could be achieved by applying the proper agricultural practices such as the organic soil conditioners. So, the

recent world attention is directed towards utilization of plant residues as organic soil conditioners.

In Egypt, an enormous amount of plant residues is left after harvest. Utilization of these residues is largely for burning, industrial terminuses or as animal feed. On the other hand, utilization of plant residues as soil conditioners is serviceable to maintain the soil fertility through the biological process in which microorganisms decompose organic materials, consuming oxygen and producing carbon dioxide, water and heat into the soil (Hong *et al.*, 1997 and Hong *et al.*, 1998). Moreover, the natural organic materials play an important role in availability of macro and micronutrients through its active groups fulvic and humic acids which have the ability to retain such metals in complex and chelate form. The organic acids are produced during the decomposition of organic matter in the soil, influencing the soil pH, consequently, increasing the availability of macro and micronutrients (El-Abaseri *et al.*, 1996; Kumar and Goh 2000; El-Fayoumy *et al.*, 2000; Goh *et al.* 2001; Phongpan and Mosier, 2002;

and IAEA, 2003).

The objective of this study is to identify the effect of organic fertilization methods using sugar beet tops on soil characteristics and the performance of rice mechanical drilling and the total rice yield.

## Material and Methods

### Experimental Procedure

#### Soil Characteristics:

To fulfill the objective of this study, a field experiment of 1 feddan (70 × 60 m)(0.42 ha) was carried out at Kalabsho Region, El-Dakhlia Governorate, during 2012 summer season. As indicated in **Tables 1** and **2**, the soil was analyzed mechanically and chemically according to the standard procedures cited by El-Serafy and El-Ghamry (2006).

### Agricultural Practices

#### Seed Bed Preparation:

The seed bed was prepared using a chisel plough in one pass at 0.20 m depth. Then, the organic fertilizer of sugar beet tops at the rate of 3 Mg/fed was manually broadcasted in regular distribution upon the soil surface. The secondary tillage was performed using a rotary plough (one and two contrary passes). The land leveling was carried out using

a mounted hydraulic land leveler of 1.26 m<sup>3</sup> capacity (0.60 × 3.00 × 0.70 m). Some chemical constituents of sugar beet tops are presented in **Table 3**.

#### Planting Process:

A selected seeds of Giza 178 rice variety were drilled with a rate of 60 kg/fed. using a mounted seed drill of 21 rows with 0.15 m row spacing. The seed drill was operated using a 2 WD tractor of 45 kW power.

All other practices were done according to the recommendations of Rice Res. Dept., Field Crops Res. Inst., Agr. Res. Center, Ministry of Agriculture and Land Reclamation.

### Treatments and Statistical Design

During the experimental work the following treatments were tested:

1. Organic fertilization at the rate of 3 Mg/fed tilled in the soil using a chisel plow followed by rotary plough (one pass - two passes and without rotary tillage) and a land leveling using hydraulic land leveler.
2. Seed drill forward speeds of 2.25, 3.60, 4.95 and 6.30 km/h at 1st, 2nd, 3rd and 4th slow gears, respectively of full throttle (around 75-80% of tractor engine speed).

The experimental work was de-

signed statistically as a split plots with three replications. The main plots were devoted for the organic fertilization with plowing treatment levels. The sub plots were located for the seed drill treatment levels.

### Measurements

#### Machinery Performance:

Machinery performance was determined as cited by Kepner *et al.* (1982) as follows:

Actual field capacity (AFC):

$$AFC = 1 / ATT \text{ fed/h} \dots \dots \dots (1)$$

Where:

ATT is the actual total time required for acting one fed, hrs.

Tractor wheel slip (S):

$$S = [(v_1 - v_2) / v_1] \times 100 \% \dots \dots \dots (2)$$

Where:

v<sub>1</sub> is the machine forward speed without load, m/s.

v<sub>2</sub> is the machine forward speed with load, m/s.

Specific mechanical energy requirements (SME):

$$SME = [(11.41 \times FC) / AFC] \text{ MJ/fed} \dots \dots \dots (3)$$

Where:

FC is the fuel consumption, Lit/h.  
11.41 is the transformation coefficient from lit/h to MJ.

Seed drill wheel skidding (sk):

$$sk = [(L - 3.14 D) / L] \times 100 \% \dots \dots \dots (4)$$

Where:

L is the actual distance per one seed drill wheel revolution, m.

D is the diameter of the seed drill wheel, m.

#### Uniformity of Plant Distribution:

Plant distribution uniformity was estimated as the coefficient of variation (c.v.) from average number of plants at the unit area in lateral or longitudinal direction (Steel and Torrie, 1980):

$$cv = (\sigma_n / S_r) \times 100 \% \dots \dots \dots (5)$$

Where:

σ<sub>n</sub> is standard deviation of seed spacing along the same row, m.

S<sub>r</sub> is recommended seed spacing along the same row, m.

### Soil Characteristics

At harvest, the soil moisture con-

**Table 1** Soil mechanical analysis of the experimental site

Soil layer, m	Sand, %			Silt, %	Clay, %	Soil texture class
	Coarse, %	Fine, %	Total, %			
0-0.3	80.25	3.10	83.35	9.55	7.10	Sandy

**Table 2** Soil Physical and chemical characteristics of the experimental site

Moisture content (d.b.), %	Bulk density, g/cm <sup>3</sup>	Infiltration rate, mm/h	Ec, dS/m	pH, 1 : 2.5	Available N, ppm	Available P, ppm	Available K, ppm
18.12	1.59	33.54	4.28	7.80	21.55	14.44	321.29

**Table 3** Some chemical constituents of sugar beet tops

Moisture content (d. b.), %	Ash, %	Organic matter, %	Organic carbon, %	Total N, %	Total P, %	Total K, %	C/N ratio
7.08	14.42	77.51	44.96	1.096	0.67	2.45	41.02



tent and the soil bulk density were determined according to ASAE (1992), the soil pH and the soil salinity were determined as cited by Black *et al.* (1965), the soil infiltration rate was determined according to Garcia (1978) and the available soil macronutrients concentration was determined according to Hesse (1971).

### Macronutrients Uptake by Rice Plants

At harvest, across each plot, rice grain samples were collected from 12 plants. As cited by El-Serafy and El-Ghamry (2006), the samples were weighed and digested. The uptake N, P and K by rice plants were determined as follows:

1. The uptake N was determined using a micro-Kjeldahl procedure.
2. The uptake P was determined color metrically using the chirostammous molybdophosphoric blue color method.
3. The uptake K was determined using the flame photometer method.

#### Rice Crop Yield:

Across each experimental unit, an area of 1 m<sup>2</sup> is taken randomly to determine rice crop yield (grain and straw). Then, it was calculated on basis of 14 % moisture content (d.b.).

#### Statistical Analysis:

SAS computer software package was used to employ the analysis of variance test and the LSD tests for

rice crop yield data.

#### Regression and Correlation Analysis:

Microsoft Excel 2010 computer software was used to employ the simple regression and correlation analysis to represent the relation between rice crop yield and the organic fertilization method under different seed drill forward speed levels.

## Results and Discussion

### Performance of Seed Drill

#### Effect of Seed Drill forward Speed on Field Capacity:

Fig. 1 shows that as the seed drill forward speed increased from 2.25 to 6.30 km/h, the field capacity increased from 0.78, 0.82 and 0.85 to 1.88, 2.00 and 2.31 fed/h for the organic fertilization methods of without rotary ploughing, rotary ploughing (1 pass) and rotary ploughing (2 passes), respectively. This trend demonstrated that the seed drill manipulates lower operating time per unit area with the increasing of machine forward speed.

#### Effect of Seed Drill forward Speed on Tractor Wheel Slip:

On the same time Fig. 2 exhibits that as the seed drill forward speed increased from 2.25 to 6.30 km/h, the tractor wheel slip increased from 3.72, 3.35 and 3.15 to 6.80, 6.50 and 6.00 % for the previous

organic fertilization methods with the same respect. This result may be proved that at the higher forward speed of the seed drilling machine, the tractor wheels fail to overcome the attractive force due to the insufficient traction power.

#### Effect of Seed Drill forward Speed on the Specific Energy Requirement:

Fig. 3 shows that as the seed drill forward speed increased from 2.25 to 6.30 km/h, the specific energy requirements decreased from 3.71, 3.35 and 2.95 to 1.85, 1.35 and 1.21 MJ/fed for the previously mentioned organic fertilization methods respectively. This trend may be explained that at the higher forward speed, the lower rolling resistance decreases the required force to deflect tractor wheels to push the disturbed soil and to overcome wheel and axle bearing friction, resulting in lower draft, consuming lower amount of fuel.

#### Effect of Seed Drill forward Speed on the Seed Drill Wheel Skidding:

Fig. 4 construes that as the seed drill forward speed increased from 2.25 to 6.30 km/h, the seed drill wheel skidding increased from 2.61, 2.20 and 2.05 to 3.95, 3.80 and 3.00 % for the previous organic fertilization method levels respectively. This relation is attributed to the seed drill instability at the higher forward speed which increases the seed drill vibration, resulting in diminishing

Fig. 1 Effect of seed drill forward speed on field capacity

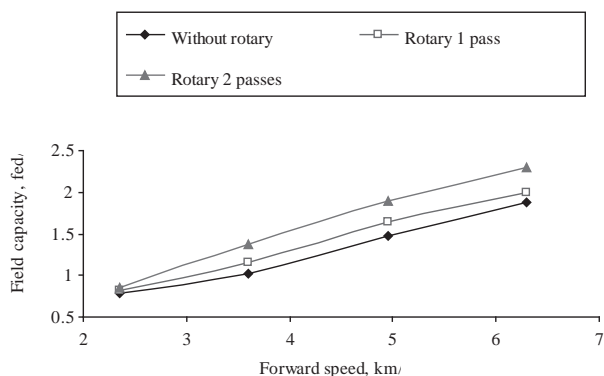
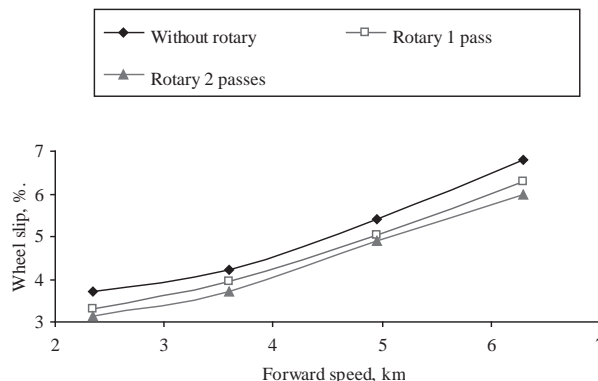


Fig. 2 Effect of seed drill forward speed on tractor wheel slip



the contact area between the seed drill wheel and the soil surface.

In general, the previously mentioned data revealed that the rotary ploughing (2 passes) achieved more acceptable seed drill performance. This is due to the resulted higher degree of pulverized soil which decreases the rolling resistance required to pull the tractor and the seed drill.

**Uniformity of Plant Distribution:**

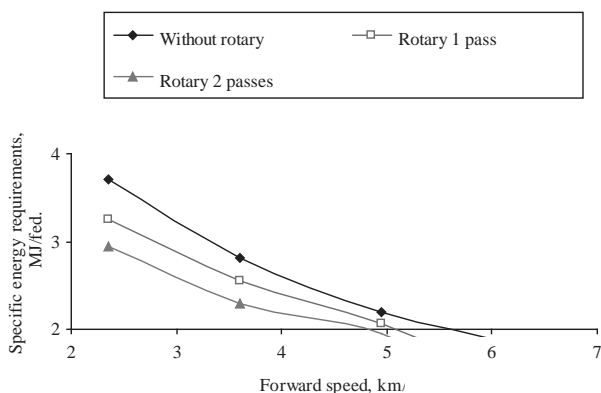
Fig. 5 shows that higher plant distribution uniformity coefficients of 88, 90 and 93 % were achieved at the seed drill forward speed of 2.35 km/h for the organic fertilization methods of without rotary ploughing, rotary ploughing (1 pass) and rotary ploughing (2 passes), respectively. These results agreed with the

phenomena, i.e., the plant distribution uniformity is proportional with the degree of soil pulverization. The higher degree of soil pulverization decreases the seed kinetic energy, resulting in lower seed rolling motion. Then, the accuracy of seed deposition increases. On the other hand, at the higher seed drill forward speed, the machine wheel skidding increases, resulting in lowering the released seeds from the feeding system. Also, at the higher seed drill forward speed, the machine vibration increases, leading to the increased kinetic energy of the released seeds from the feeding system. Then, the seeds rolling motion abounds, resulting in lower accuracy of seed deposition.

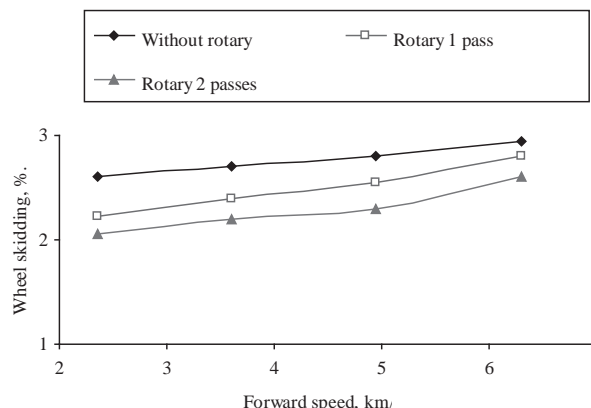
**Soil Characteristics:**

Table 4 demonstrates that the rotary ploughing (2 passes) accomplished more desirable soil characteristics of 1.28 g/cm<sup>3</sup> bulk density, 18.11 mm/h infiltration rate, 2.14 dS/m salinity, 6.00 pH and 27.00, 18.20 and 347.00 ppm available N, P and K concentration, respectively. This tendency explained that the rotary ploughing (2 passes) accomplished fine soil particles which having a negligible electromagnetic charge. So, the soil free pore spaces per unit volume increased, resulting in lower soil bulk density. Moreover, the irrigation water streams, detaches soil particles from the surface and pushes fine particles into the surface pores, creating a smaller pores offering greater resistance to the gravity, where they can impede

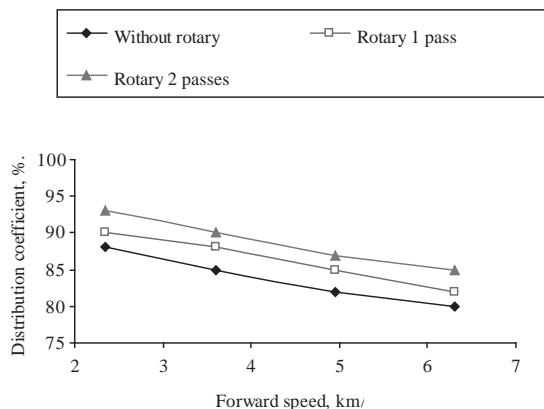
**Fig. 3** Effect of seed drill forward speed on specific energy requirements under different skidding of seed drill



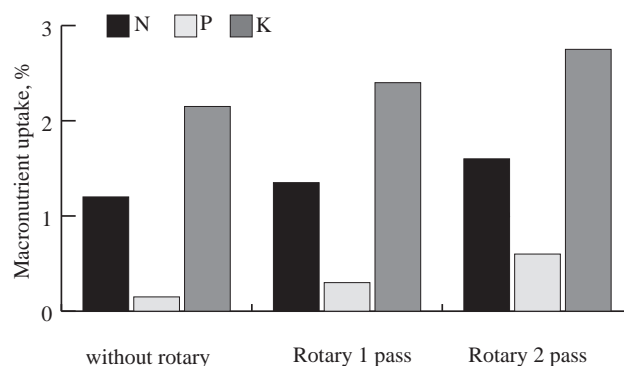
**Fig. 4** Effect of seed drill forward speed on wheel skidding under different organic fertilization methods



**Fig. 5** Effect of seed drill forward speed on plant distribution uniformity coefficient under different organic fertilization methods



**Fig. 6** Effect of organic fertilization methods on macronutrients uptake by rice plants



**Table 4** Effect of organic fertilization methods on soil characteristics

Organic fertilization method	Bulk density, g/cm <sup>3</sup>	Infiltration rate, mm/h	Ec, dS/m	pH, 1 : 2.5	Available N, ppm	Available P, ppm	Available K, ppm
Without rotary ploughing	1.40	23.14	3.00	7.00	24.15	15.34	331.50
Rotary ploughing (1 pass)	1.35	21.23	2.43	6.55	25.56	17.55	339.80
Rotary ploughing (2 passes)	1.28	18.11	2.14	6.00	27.00	18.20	347.00

the infiltration process, resulting in lower value of soil salinity. Also, the decomposition of the sugar beet tops may make the soils tend to become acidic as a result of carbon dioxide release, leading to lower value of soil Ph. In addition, the finer soil particles of greater specific surface area allowed to release more amounts of the available soil macro-nutrients.

Also, the data showed a significant effect of the organic fertilization on improving the soil characteristics. This may be attributed to the soil biological activity in which microorganisms decompose the soil organic matter, consuming oxygen and producing carbon dioxide, water and heat into the soil which maintaining the soil fertility.

#### **Macronutrients Uptake by Rice Plants:**

**Fig. 6** indicates that the rotary ploughing (2 passes) recorded higher macronutrients uptake by rice plants with a values of 1.60, 0.60 and 2.75 % for N, P and K, respectively. This finding is attributed to the aeration process which increases

mineralization that allowed the soil to release more amount of the available nutrients, to be up taken by rice plants, thereby improve the supply of nutrients. Moreover, data reveal that using the organic fertilization enhanced uptake of more nutrients by rice plants. Also, it encouraged the biological fixation of the atmospheric Nitrogen, which increase the amount of N uptake. In addition, the sugar beet tops decomposition increases the solubility of native phosphrus by means of organic acids that produced during the tops decomposition. Meanwhile, the increase in the available soil K is attributed to the release of K from the added tops and the native source as well as the retention of K by the soil organic matter against leashing.

#### **Rice Crop Yield:**

**Fig. 7** exhibits that the higher rice grain and straw yield value of 4.40 and 5.00 Mg/fed was obtained by applying a sugar beet top mixing during the chisel plow tilling followed by rotary plough (2 passes) as an organic fertilization method. This finding is due to the higher

degree of plant distribution uniformity that diminishes the plant competition which affects the growth factors i.e. light, water and nutrients uptake. In addition, this result means that, the rice grain yield was affected significantly by the organic fertilization which improves the soil characteristics and enhancing, it to

release the available nutrients, resulting in more NPK uptake by rice plants.

The analysis of variance test indicated that there is a significant difference in rice grain yield due to organic fertilization method treatment. LSD test at 0.05 level shows that rotary plough (2 passes) achieved higher rice grain yield among the other treatment levels.

The regression and correlation analysis revealed that there is a highly significant positive correlation between rice crop yield (y) and rotary ploughing pass times (x) as follows:

$$\text{Grain: } y = 0.300x + 3.482$$

$$R^2 = 0.9994$$

$$\text{Straw: } y = 0.325x + 4.016$$

$$R^2 = 0.9515$$

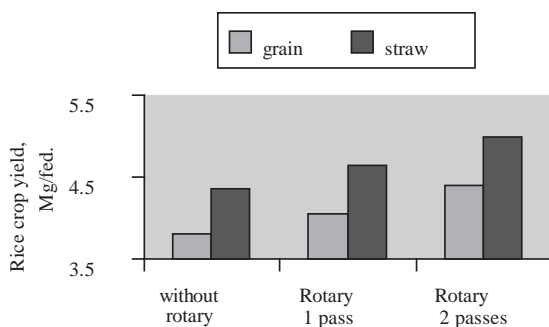
## **Conclusion**

The obtained results of this study could be concluded the following:

1. The chisel plow followed by rotary ploughing achieved higher and acceptable seed drill performance.
2. The rotary ploughing (2 passes) achieved the highest plant uniformity coefficient of 93 %.
3. The rotary ploughing (2 passes) achieved more desirable soil characteristics and fertility.
4. The rotary ploughing (2 passes) achieved the highest rice grain yield of 4.40 Mg/fed.

## **REFERENCES**

ASAE standard: S296.4 (1992). Cubes, Pellet, and crumbles-defini-

**Fig. 7** Effect of organic fertilization method on rice crop yield

- tions and methods for determining density, durability and moisture content: 384.
- Black, C. A., D. D. Even, J. L. White, L. E. Ensminger, and F. E. Clark. 1965. Methods of soil analysis. Part 1, American Soc. Of Agromomy. Inc. Pub., Wisc., U.S.A.
- El-Abaseri, M. A., H. A. Shams El-Din, M. A. Ghazy, and M. A. Abou El-Soud. 1996. Effect of sand constructed tunnels on the productivity of clayey salt affected soils. *Misr J. Ag. Eng.* 13(4): 3-4.
- El-Fayoumy, M. E., E. I. El-Maddah, and H. M. Ramadan. 2000. Effects of sludge-sulphur applications as soil amendments on some Egyptian soil properties and productivity of wheat and corn. *Egypt. J. Appl. Sci.* 15(12): 323-349.
- El-Serafy, Z. M. and A. M. El-Ghamry. 2006. Methods of soil and water analysis (Practices), Soils Dept., Fac, Ag., Mansoura Univ., 253 pp.
- Garcia, I. 1978. Soil-Water Engineering. Laboratory Manual. Dept. of Agricultural and Chemical Engineering, Colorado State University, Fort Collins, Colorado, U.S.A.
- Goh, K. M., D. R. Pearson, and M. J. Daly. 2001. Soil physical, chemical AND biological indicators of soil quality in conventional, biological and integrated apple orchard management systems. *Biol. Ag., Hort.* (18): 269-292.
- Hesse, P. P. 1971. A text book of soil chemical analysis. John Murray, pup., London Great Britan.
- Hong, J. H., K. J. Park, and B. K. Sohn. 1997. Effect of composting heat from, intermittent aerated static pile on the elevation of underground temperature. *Applied Engineering in Agriculture.* 13(5): 679-683.
- Hong, G. H., H. M. Keener, and D. L. Elwell. 1998 a. The effect of continuous and intermittent aeration on composting hog manure amended with sawdust –progress report. An ASAE Meeting Presentation. Paper No. 984098.
- IAEA. 2003. Management of crop residues for sustainable crop production. IAEA –TECDOC- 1354.
- Kepner, R. A., R. Beiner, and E. L. Barger. 1982. Principles of farm machinery. 3rd Ed., The AVI Pup. Co. Inc. 527 pp.
- Kumar, K. and K. M. Goh. 2000. Crop residues and management practices effect on soil quality, soil nitrogen dynamics, crop yield and nitrogen recovery. *Adv. Agron.* (68): 197-319.
- Phongpan, S. and A. R. Mosier. 2002. Effect of Rice Straw Management on nitrogen balance and residual effect of Urea-N in an annual lowland Rice Cropping sequence. *Biology and Fertility of soils.* (37): 102-107.
- Srivastava, A. K., C. E. Goering, and R. P. Rohrbach. 1995. Engineering Principals of Agricultural Machines. ASAE Textbook Number 6. Pamela De Vore-Hansen, Editor Information Publishing Group, U.S.A.
- Steel, R. G. and S. H. Torrie. 1980. Princibles and procedures of Statistics. Mc Craw-Hill Co.

■ ■

## New Co-operating Editor



**Hemanatha P. W. Jayasuriya**

**Date of Birth:** 17 / 06 /1958

**Nationality:** Sri Lanka

**Current Grade:** Associate Professor (AB), Head, Dept. of Soils, Water and Agricultural Engineering, College of Agricultural and Marine Sciences Sultan Qaboos University, Oman

**Education:**

Jan 1997 -Dec. 1999: PhD. in Agricultural Machinery. (AIT, Thailand)

Research area: Terramechanics / Equipment Design / Modeling & Simulation /Soil too interactions

Jan 1988 -Aug. 1989: M.Eng. in Agricultural Machinery (AIT, Thailand)

Research area: Terrmechanics / Equipment Design / Agric. Machinery

Sept. 1979 -Dec. 1983: B.Sc. Eng. (Hons.) in Mechanical-Production Engineering, Faculty of Engineering, University of Peradeniya, Sri Lanka. (Top student in Mechanical-Production stream)

**Positions held in Professional bodies:**

- Vice President, Asian Association for Agricultural Engineers (AAAE) (2010 - to date)
- Treasurer, AAAE, 2007-2010
- Executive Committee, Asian Precision Agriculture Association (2007-2010)

# Characterising the Performance of a Deep Tilling Down-Cut Rotavator Fitted with L-Shaped Blades

by

M. O. Marenya

Department of Agricultural and Rural Engineering,  
University of Venda, P/Bag X5050, Thohoyandou 0950, &  
Institute for Agricultural Engineering, Agricultural Research Council,  
P/ Bag X519, Silverton, 0127,  
SOUTH AFRICA  
moses.marenya@univen.ac.za

## Abstract

Field experiments were conducted in a sandy loam soil using a purpose-built down-cut deep tilling experimental rotavator mounted on an instrumented tool-frame carrier. The instrumentation of the tool-frame carrier allowed for the simultaneous measurement of vital rotavator operational parameters required to evaluate its field performance. The parameters recorded included forward thrust forces generated, blade angular position, blade torque requirement, blade rotational speed, set tillage depth, and forward travel speed. The rotavator kinematic parameter,  $\lambda$ , was determined for forward travel gears I and II at a fixed rotavator rotational speed of 60 rpm giving values of  $\lambda$  of 6.026 and 4.944, respectively. The experiments were carried at 200-550 mm tillage depth range, in steps of 50 mm, at constant soil water content levels for three and six blades on the flange. The findings indicated that the magnitude and variations of the resultant forward thrust force depended on the bite length, set tillage depth, and the kinematic parameter,  $\lambda$ ; and that there exists a unique depth for each rotavator configuration and operational condition

at which the forward thrust force generated is greatest. Compared to other operational parameters, the bite length had a greatest effect on the rotavator torque requirements. Therefore, it is imperative that a tighter control over possible changes in the kinematic parameter,  $\lambda$ , is ensured during tillage with rotavators.

**Key words:** down-cut rotavator, deep tillage, tiller performance, kinematic parameter, specific energy

## Introduction

The rotavator, derived from rotary cultivator, or rotary tiller is a tillage tool comprised of L-shaped blades mounted on flanges, that are attached to a shaft driven by the tractor power-take-off (PTO) shaft. It is an active tillage tool that processes the soil at a speed that is different from the forward travel speed of the tractor. With respect to depth of tillage, the rotavator is unique because during its operation, the actual depth of tillage for each blade changes throughout the rotational path of the cutting operation (Marenya, 2009). The performance of a rotavator is affected by many factors such as blade configuration, direction of rotation, set tillage depth and

kinematic parameter,  $\lambda$ . The rotavator kinematic parameter is the ratio of the blade rotational speed to the forward travel speed (Hendrick & Gill, 1971a).

Rotavator blades may be rotated on vertical-axis or horizontal-axis rotor shafts. The horizontal rotavator axis rotavators may be operated in the up- or down-cut directions of rotation. Down-cut rotavators may exert a forward force/thrust to the tractor driveline while the up-cut ones pull the tractor rearwards. The forward thrust, generated by the down-cut rotavator, though possibly detrimental to the tractor driveline, offers several advantages for crop farming (Manian & Kathirvel, 2001; Shinnars, Wilkes & England, 1993). Some of these advantages include: 1) the thrust force generated by the rotavator can be used as traction aid and can therefore contribute significantly to the reduction of the rolling resistance of a tractor, 2) the reduced draught results in less wheel slip at the tractor tyre-soil interface, thus improving field productivity and efficiency, 3) the reduced draught allows for the use of lighter tractors, thus reducing the soil compaction and the purchase price of tractors to operate rotavators, 4) the reduced draught of rota-



vators also allows tillage operations to be performed in more difficult traction conditions, which has great potential for improving timeliness of the entire crop production system (Marenya, du Plessis & Musonda, 2003; Shinnars *et al.*, 1993).

To date, the application of rotavators in crop production systems, demanding the manipulation of the soil at deeper depths, appears to be hindered by the perceived excessive energy requirement. Owing to this, commercially available rotavators are designed for shallow tillage, i.e., tillage depths less than 200 mm (ASAE Standards, 2000). According to Manian and Kathirvel (2001), the view of the excessive energy consumption by rotavators only holds when the energy consumption of the rotavator is compared to the energy consumed by individual passive tillage tools or operation(s), without considering the quality of the resultant tilth, and the number of tillage operations required under conventional tillage. When the total energy demand for producing an acceptable tilth is considered, the series of passive tillage operations needed to realise the same tilth consumes more specific energy than the rotavator (Manian & Kathirvel, 2001; Prasad, 1996).

As with any other tillage tool, the depth of operation has significant influence on the power requirement and performance of a rotavator (Shibusawa, 1993). Hendrick and Gill

(1971b) reported that increasing the depth of operation, while holding other rotavator design parameters and soil conditions constant, resulted in increased energy requirement for both directions of rotation. From the previous research work reviewed by Hendrick & Gill (1971b), there was no consensus on the relationship between depth and energy requirements. In most cases, specific energy requirement increases at an increasing rate with the depth of tillage (Shibusawa, 1993). Some studies, however, have shown a linear relationship between increments in these two factors for the same soil conditions for a given rotavator (Beeny & Khoo, 1970). This increasing rate of the specific energy requirement with depth has been the main reason for restricting the rotavator to shallow tillage, i.e., tillage to set maximum depths of under 200 mm (ASAE Standards, 2000). A combination of tillage depth, with increasing blade rotational velocity, results in a rapid increase in specific energy requirement (Hendrick & Gill, 1971b).

According to Hendrick and Gill (1971a, b), power requirements of rotavators might be reduced by considering the relationships between the tiller design and its operational parameters. These parameters include the direction of rotation of the blades (Salokhe & Ramalingam, 2001), depth of tillage, ratio of peripheral speed to the forward travel

speed ( $\lambda$ ), blade configuration (Salokhe, Hanif & Hoki., 1993) and the soil condition. From the profitable farming perspective, the rotavator holds immense potential for reducing the cost of producing crops especially if methods for reducing its excessive power requirements in deep tillage can be found. One way of doing this is to carry out studies that would establish the effects of the rotavator design parameters on its performance. This can be accomplished by designing and fabricating a deep-tilling rotavator with requisite instrumentation so as to obtain information on its field performance parameters for use in studying its performance (Marenya *et al.*, 2003).

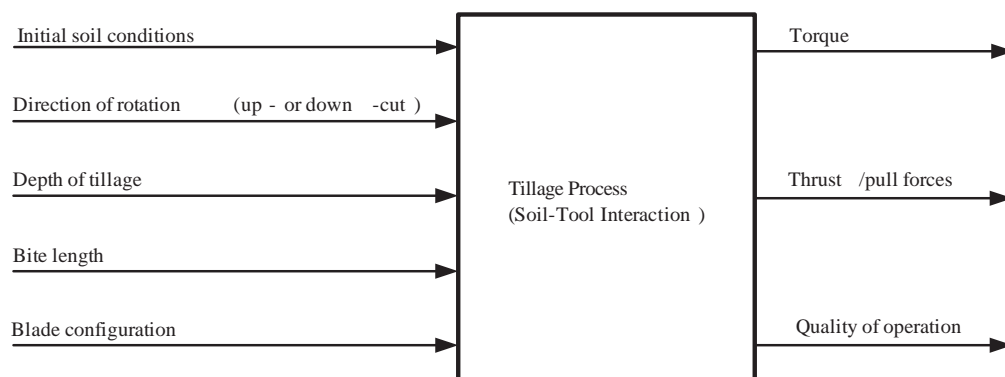
The aim of this study was to quantify the performance of a down-cut rotavator. The specific objectives were to: 1) design, fabricate and test an instrumented experimental deep-tilling rotavator setup, fitted with available commercial rotavator blades, and 2) quantify the field performance of the experimental deep-tilling rotavator in terms of its specific energy or power requirements over a wide range of set tillage depths.

## Materials and Methods

### Conceptual Formulation

A block diagram (Fig. 1) was proposed as a basis for assessing the performance of a deep tilling rotava-

Fig. 1 A block diagram for the characterizing the performance of a rotavator





tor fitted with L-shaped blades. The block diagram includes rotavator tillage and output operational and design factors such as the direction of the blade rotation, bite length, initial soil condition, depth of tillage and blade configuration; all factors having considerable influence on the rotavator performance indicators. These indicators include torque requirement, the resultant thrust/pull forces and tilling quality of the resultant tilled soil. The study was limited to the down-cut direction of rotation because up-cut rotation rotavators are not currently in use. This conceptual formulation was followed by designing and fabricating an instrumented down-cutting rotavator able to measure and quan-

tify the input and output parameters.

Based on this block diagram (Fig. 1), an experimental deep tilling down-cut rotavator fitted with L-shaped blades was designed and instrumented to measure the stated input and output parameters. The tillage process depicted in this block diagram was treated as a 'black-box' and therefore, knowledge of the internal structure soil-blade interactions were not taken into consideration.

### The Instrumented Experimental Deep Tilling Down-Cut Rotavator

The tiller comprised a tool-frame carrier, a variable displacement hydraulic pump, a hydraulic motor, and seven transducers for measur-

ing the desired input and output parameters (Fig. 2). The tiller tool-frame carrier was attached to a tractor through the two lower links and the top link. The tiller was driven by a constant displacement hydraulic motor (component 9). The hydraulic motor was driven by a bi-directional variable displacement hydraulic pump (Bosch, Germany), which was in turn, driven by the tractor PTO shaft.

Commercially available standard L-shaped blades were purchased from a local supplier (component 12, Fig. 2). Fig. 3 shows the detailed blade, extension arm and flange arrangement for a single blade. The blades were secured at the lower ends of 600 mm long steel extension arms of 80 mm by 30 mm as shown. The other end of the extension arms were fixed onto a 16 mm thick circular flange of 800 mm diameter fixed to the hydraulic motor.

### Data Acquisition System (Das)

The output signals from all the transducers on the tool-frame carrier were fed to a state-of-the-art commercial data acquisition system (DAS). The DAS used was the Spider8 (Hottinger Baldwin Messtechnik, Germany), and its associated software (CARTMAN EXPRESS version 3.1 for Windows). A schematic layout of the DAS is shown in Fig. 5. The DAS comprised eight (8) input channels. Only the first seven channels, corresponding to the number of transducers on the tool-frame carrier were utilized for simultaneous measurement of the parameters required to evaluate the performance of the rotavator. Each channel had a separate A/D converter, with capability for data recording for 1 Hz to 9.6 kHz frequency range. Field experimental data was recorded at a frequency of 2.4 kHz. This was the frequency at which the measured data from all the transducers (Figs. 2 and 4) registered the proper signals.

Fig. 2 The fabricated experimental deep tilling rotavator setup showing the key functional components

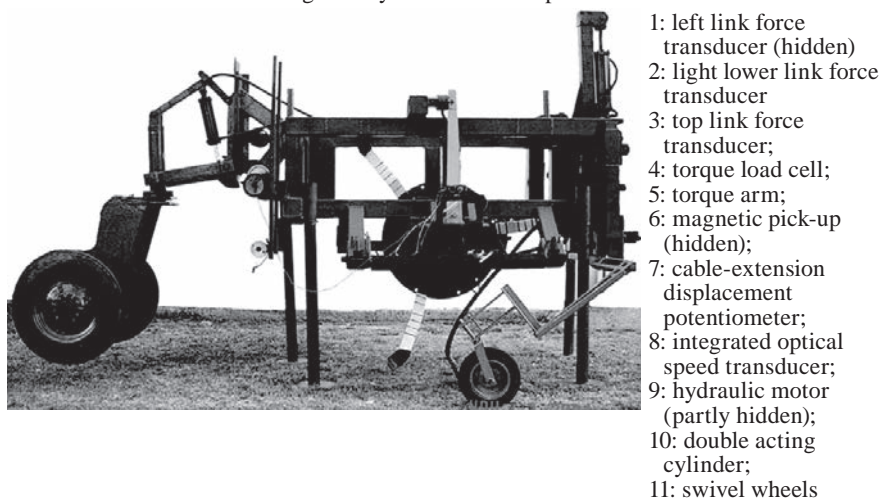
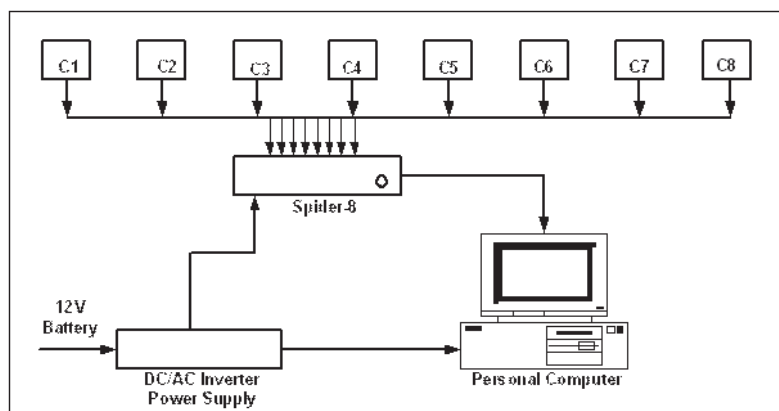


Fig. 3 Schematic diagram of the DAS (C1...C8 –measurement channels)



**Field Experiments**

Field experiments were carried out at a suitable site at the University of Pretoria’s experimental farm at Hatfield, Pretoria, South Africa. **Figs. 4 and 5**, respectively, show the experimental setup and layout used for the tillage test trials. Using the layout shown in **Fig. 6**, field experiments were conducted to determine the effect of set tillage depth, forward travel speed, and bite length for a fixed average soil water content level on torque/ specific energy requirements and the push/pull

**Table 1** Comparison of the percentage increases in depth and mean torque requirements for a fixed rotavator configuration and operational conditions; and a fixed soil condition

Tillage depth		Torque requirements	
Depth, mm	% increase	Mean torque requirement, Nm	% increase
250	0	450	0
300	20	876	93
450	80	3,198	611

forces generated. The bite length is the horizontal distance between any two successive blades entries into the ground surface during rotavator tillage (**Fig. 6**) and was calculated

as (Sineokov & Panov, 1978):

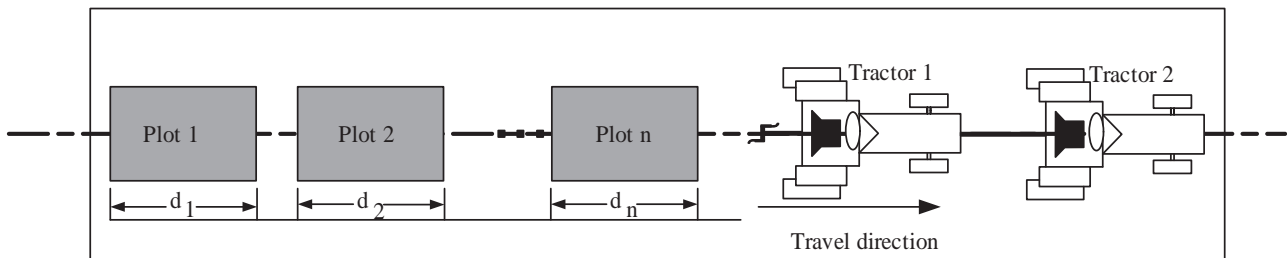
$$L_b = (2\pi V_f / z\omega) \text{ or } L_b = (2\pi R / \lambda z) \dots\dots\dots (1)$$

Where:  $V_f$  = forward travel velocity of the tractor (m/s);  $z$  = number of

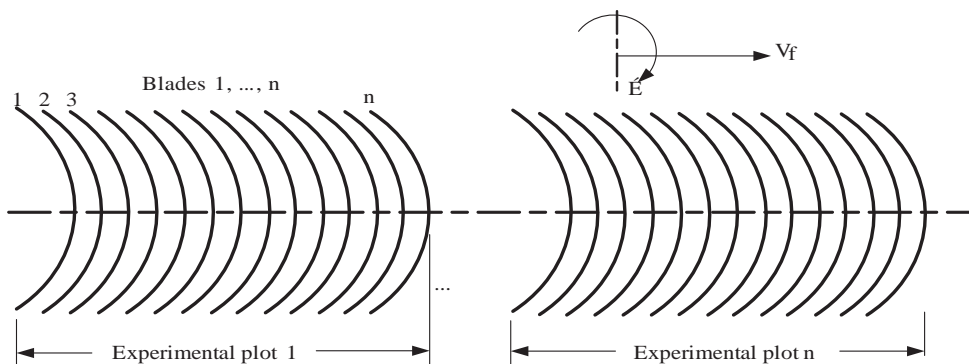
**Fig. 4** Setting-up for a tillage test-run [the swivel wheel at the rear end of the rotavator tool-frame carrier was lifted off the ground during tillage experiments and the depth setting was controlled by the tractor three-point hitch system



**Fig. 5** Experimental layout ( $d_1, d_2 \dots d_n$  –distance covered in respective plots during a test run)



**Fig. 6** Illustrations of the subsequent cutting paths by individual blades within experimental blocks for experimental plots 1 ...n



blades one side of the flange, and  $\omega$  = rotor speed (rad/s)

## Results and Discussion

### Effect of Set Tillage Depth at Constant Kinematic Parameter, $\lambda$

Fig. 7 shows typical variation in torque requirement curves with depth for soil processing by a single blade at different tillage depths. These curves indicate that rotavator torque requirements increase with the tillage depth. In terms of the rates of increase, it is apparent from the curves that torque requirements increase at a rate higher than the rate of increments in depth. A number of previous researchers (Hendrick & Gill, 1971a; Shibusawa, 1993; Manian & Kathirvel, 2001; Marenya & du Plessis, 2006) made similar observations for rotavators operated within the ‘normal’ set tillage depth range, i.e., set tillage depths not exceeding 250 mm.

Table 1 is a summary of the percentage increments in depth and associated mean torque requirements

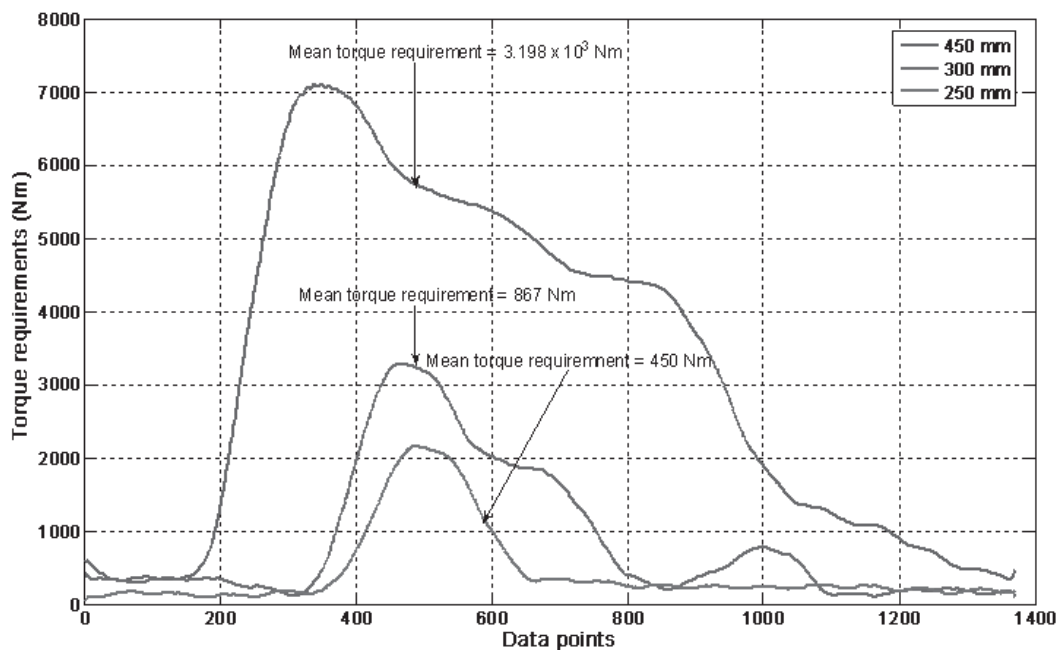
for the single blade data presented in Fig. 8. From this data, excessive torque requirements accompany relatively small increments in the depth of tillage. This observation is consistent to that made by other researchers (Hendrick & Gill, 1971a; Shibusawa, 1993); and is responsible for the lack of adoption of the rotavator as an alternative primary tillage tool (Marenya *et al.*, 2003).

The causes of the mentioned excessive energy consumption by rotavators in deep tillage are many and varied. However, the above mentioned studies did not attempt to address them. The objective of these studies was simply to compare the energy demanded or consumed by different primary tillage tools under specified conditions. By contrast this study addressed the causes of the excessive energy consumption by the deep-tilling experimental rotavator by an analyzing the theoretical equations and the rotary motion of the rotavator during tillage. In this regard, the following two physical factors are considered to be responsible for observations made

regarding the effect of tillage depth on torque requirements: 1) the tilling route length and 2) the volume of the soil processed by a rotavator blade for different set tillage depths.

Increasing the set tillage depth resulted in both increased tilling route length and volume of soil processed by a blade. The increase in torque requirement values with increasing depth is possibly caused by the increase in both the tilling route length and the volume of the soil chips cut by a blade. As the set tillage depth is increased, both the tilling route length and the volume of the cut soil chips increased at constant kinematic parameter,  $\lambda$ . The increase in the volume of cut soil slice is caused by the increase in depth since the width of the blade and the bite length are fixed at a given level of  $\lambda$ . Increasing the depth of tillage also decreases the angle of blade entry into the soil while increasing the angle at which the soil processing stops. This results in increased length of the tilling route length. For the results presented in Fig. 7, the increase in

Fig. 7 A graph showing the typical effect of depth on torque requirements for a down-cut tillage test-run for a given soil condition and fixed kinematic parameter,  $\lambda$



the tilling route length is reflected in the form of the increasing range of data points over which the values of torque is substantially greater than zero for the three different depths of tillage. The increased tilling route length means that cutting torque is required for extended periods of time, which is reflected by the significantly different torque requirements for the different set depths of tillage.

### Effect of the Bite Length

The different bite lengths,  $L_b$ , were calculated using Eqn. 1 with three and six blades on the same side of the flange for two forward travel gears. The two forward travel gears resulted in two different forward speeds,  $V_f$ . Since the rotavator rotational speed was fixed, the combination of the two forward travel speeds and the two sets of the number of blades, resulted in four different values for the kinematic parameter, and hence four different bite lengths. The calculated bite lengths for the four different values of the kinematic parameter  $\lambda$ , are given in Table 3.

Fig. 8 shows the variation of torque requirements for bite lengths of 0.323 m and 0.162 m (Table 3), respectively, with the rotavator traveling at a forward speed of 0.425 m/

**Table 2** Calculated bite lengths for different number of blades on the flange,  $z$  and the forward travel speeds,  $V_f$

Combination of number of blades and forward travel speed	Bite length, cm
1. Forward travel on gear I and 3 blades on the flange	32.3
2. Forward travel on gear I and 6 blades on the flange	16.2
3. Forward travel on gear II and 3 blades on the flange	39.2
4. Forward travel on gear II and 6 blades on the flange	19.6

**Table 3** Theoretical soil chip volumes processed by the experimental rotavator for different experimental setups

Tillage depth (mm)	Soil volume processed (m <sup>3</sup> )			
	$\lambda_I = 6.026$		$\lambda_{II} = 4.944$	
	6 blades	3 blades	6 blades	3 blades
250	0.0032	0.0065	0.0039	0.0078
300	0.0039	0.0078	0.0047	0.0094
350	0.0045	0.0091	0.0055	0.0109
400	0.0052	0.0103	0.0062	0.0125
450	0.0058	0.0116	0.0070	0.0140
500	0.0065	0.0129	0.0078	0.0156
550	0.0071	0.0142	0.0086	0.0172

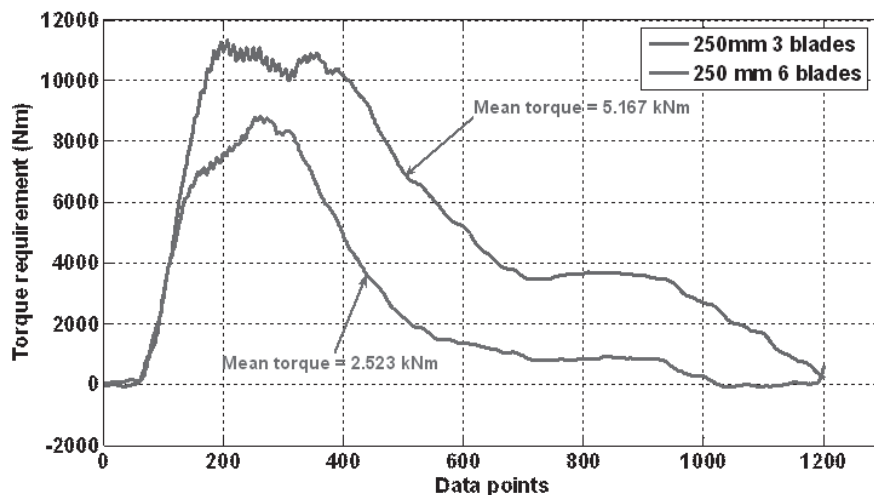
s, and processing the soil at a set tillage depth of 250 mm. The comparison of the mean torque requirement values for the two different bite lengths for this set the tillage depth indicated increasing the bite length by 0.162 m resulted in more than 100 % increase in the mean torque requirement value. The observed effect of changing bite length on the torque requirement can be explained by considering the soil volume processed by single blade for different levels of the  $\lambda$  and set

tillage depth (Table 3). The soil volume cut by individual blades was calculated using Eqn. 2 (Sineokov & Panov, 1978), based on the cut soil slice dimensions shown in Fig. 9 (Hendrick & Gill; 1971a).

$$V_{slice} = L_b d w_b \dots\dots\dots (2)$$

As is evident in Table 3 increasing the bite length resulted in increased average torque requirement values for the same set tillage depth. The observed increase was attributed to the increase in dimensions of the cross-sectional area and

**Fig. 8** Effect of bite length on torque requirements





the length of the tilling route (**Fig. 8**) of the soil slice cut by a blade. From these observations, changing the bite length by either reducing the number of the blades on the flange, or increasing the forward travel speed, while holding the rotor rotational speed constant results in increased cross-section area and volume of the soil slice processed by a blade. The increase in cross-sectional area and greater volume of the processed soil is what translated to greater torque requirements and longer time durations during which a blade processes the soil (**Fig. 8**).

The above results indicate that rotavator torque requirement is sensitive to changes in the bite length. Therefore, it is necessary to institute greater control for any possible changes in the value of  $\lambda$ . Since under practical conditions, the number of blades on a flange, depth of tillage and the rotational speed of the rotor can be held constant, the only possibility of changing the bite length during rotavator tillage is by operating at a varying forward travel speed. Consequently, it is critical that rotavator prime-movers are operated at a uniform forward travel speed in order to control both the torque requirement and the bite length.

### Torque, Power and Specific Energy Requirements

The specific energy requirements were expressed in terms of the en-

ergy units per volume of the soil processed (**Eqn. 3**). The power due to the resultant horizontal force was also determined for each field test using the standard force-velocity relationship:

$$\text{Specific energy} = (\text{Energy expended} / \text{Volume of the soil processed per blade}) \text{ (J/m}^3\text{)} \dots\dots\dots (3)$$

The volumes of soil slices cut by individual blades for different rotavator operational conditions tested in this study are presented in **Table 3**. **Table 4** presents a summary of the results obtained for using the approach highlighted above. The calculated parameters for analyzing the performance of the experimental deep-tilling rotavator included the average linear power generated by the resultant horizontal thrust force, the rotary power required for processing the soil slice, and the specific energy requirements at different depths for different tests.

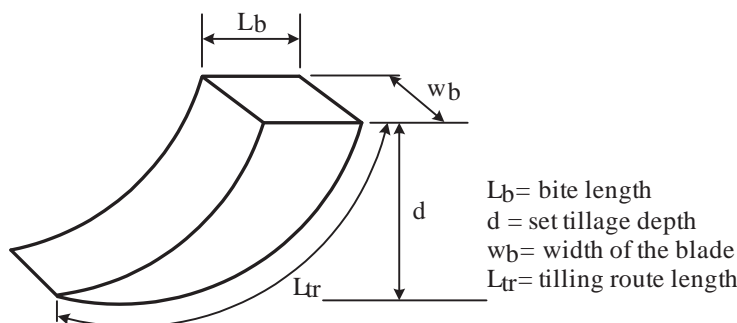
The power performance of the experimental tiller was determined by calculating the rotary and linear power requirements. The specific rotary tillage energy was calculated from the rotary power and linear power by determining the energy required for 10 complete revolutions for different conditions and then dividing this by the total volume of the soil processed. The results presented in **Table 4** indicated that increasing both the set tillage depth and bite length, influences the rotary power requirements and the

specific energy. In general, change in bite length has a greater influence on power requirements and specific energy than the change in set tillage depth. These findings are consistent with those of previous researchers (Salokke & Ramalingam, 2001; Bukhari *et al.*, 1996; Shibusawa, 1993; Hendrick & Gill, 1971b).

The power performance of the experimental tiller was determined by calculating the rotary and linear power requirements. The specific rotary tillage energy was calculated from the rotary power and linear power by determining the energy required for 10 complete revolutions for different conditions and then dividing this by the total volume of the soil processed. The results presented in **Table 4** indicated that increasing both the set tillage depth and bite length, influences the rotary power requirements and the specific energy. In general, change in bite length has a greater influence on power requirements and specific energy than the change in set tillage depth. These findings are consistent with those of previous researchers (Salokke & Ramalingam, 2001; Balock *et al.*, 1986; Bukhari *et al.*, 1996; Shibusawa, 1993; Hendrick & Gill, 1971b).

The greater influence of changes in bite length on the specific energy is attributed to changes in several factors that lead to the increase in volume of the cut soil slices. Changes in bite length have significant effects on the tilling route length, the maximum soil chip thickness, and the absolute velocity of the rotor blade tip. All these three factors individually affect the torque requirement and therefore any changes in bite length, in combination with any of them, would significantly impact the rotavator torque and power requirements. From **Table 3**, change in volume of the worked soil, owing to increase in depth, is relatively small in comparison to the change in the worked volume due to bite length changes. Hence change in

**Fig. 9** The main dimensions of a soil slice cut by a down-cut rotavator (Hendrick & Gill, 1971a)



torque and power requirements owing to changes in depth, in general are lower than changes due to an equivalent change in bite length.

The above analyses suggests that changing bite length affects a number of factors with a combined effect of greater torque and power requirements when compared to changes in depth for a fixed level of the kinematic parameter,  $\lambda$ . Thus, it is important that the kinematic parameter is maintained constant after the determination of the set tillage depth. The above results indicate that any change in the kinematic pa-

rameters would result in increased torque and power requirement of rotavators. However, the findings indicated that minor changes in depth, for example due to unevenness of the ground surface can be tolerated well in rotavator tillage. It is therefore vital that the ratio of the forward travel speed to the rotational speed, which determines  $\lambda$ , is maintained constant throughout a rotavator tillage operation.

## Conclusions

The magnitude and variations of forward thrust force generated for a down-cut tillage operation depended on bite length, set tillage depth, and the kinematic parameter,  $\lambda$ . Therefore, the rotavator configuration and operational parameters must be controlled precisely in order to realize and maintain the desirable resultant thrust force for a down-cut rotavator.

There exists a unique depth for each rotavator configuration and operational condition at which the

**Table 4** Summary of average thrust, torque, power requirements, and specific energy requirements for down-cut deep rotary tillage test-runs (soil water content of 13.97 %)

Rotavator configuration (Travel gear and number of blades on the flange)	Depth (mm)	Thrust (N)	Torque (Nm)	Power requirements (kW)		Specific energy (kJm <sup>-3</sup> )
				Linear	Rotary	
Forward gear I with six (6) blade on the flange	200	- 936	360	- 0.398	0.991	105.554
	250	- 1409	401	- 0.599	1.104	117.734
	300	- 1807	581	- 0.768	1.600	107.604
	350	- 2092	632	- 0.889	1.741	135.117
	400	- 2100	870	- 0.892	2.396	127.192
	450	- 2020	941	- 0.856	2.591	156.978
	500	- 1798	1130	- 0.764	3.112	151.504
	550	- 1415	1318	- 0.601	3.629	166.559
Forward gear II with six (6) blades on the flange	200	- 1295	604	- 0.667	1.663	187.109
	250	- 1945	712	- 1.002	1.960	191.057
	300	- 2497	975	- 1.286	2.685	217.097
	350	- 2890	1062	- 1.488	2.924	202.073
	400	- 2905	1462	- 1.496	4.026	246.776
	450	- 2783	1581	- 1.433	4.360	236.663
	500	- 2478	1902	- 1.276	5.235	255.056
	550	- 1947	2211	- 1.003	6.083	268.810
Forward gear I with three (3) blades on the flange	200	- 1736	960	- 0.738	2.643	327.657
	250	- 1946	1059	- 0.827	2.999	350.664
	300	- 2010	1512	- 0.854	4.164	405.728
	350	- 1851	1685	- 0.786	4.640	387.557
	400	- 1750	2409	- 0.743	6.634	489.528
	450	- 1379	2509	- 0.586	6.909	452.710
	500	- 1050	3031	- 0.446	8.297	488.863
	550	- 517	3552	- 0.220	9.782	523.555
Forward gear II with three (3) blades on the flange	200	-1805	1598	- 0.930	4.397	615.145
	250	-2040	1820	- 1.051	5.008	642.133
	300	-1870	2555	- 0.963	7.031	717.486
	350	-1686	2778	- 0.868	7.645	707.381
	400	-1495	3998	- 0.769	11.002	880.200
	450	-979	4212	- 0.504	11.591	827.959
	500	-549	5063	- 0.283	13.933	893.165
	550	210*	6036	0.108	16.611	965.760

\* For this setting, a draft force is exerted on Tractor 2



thrust force generated is greatest. This depth is influenced by the bite length, and decreased as the bite length is increased. Therefore the realisation and maintenance of the maximum forward thrust generation, where required, can only be realized by strictly operating a rotavator at the correct set tillage depth for a given set of rotavator configuration and operational conditions.

In general, the specific energy requirements of the rotavator increased with increment in both the set tillage depth and bite length. However, bite length had a greater influence on the specific energy requirements than the set tillage depth. Therefore, a strict control over possible changes in the bite length rather must be integrated in the design of deep-tilling down-cut rotavators as a means of controlling the potential for excessive increments in the energy demand during operation.

## REFERENCES

- ASAE Standards. 2000. ASAE Standards (47th Ed.). ASAE EP291.2 DEC98: Terminology and definitions for soil tillage and soil-tool relationships. American Society of Agricultural Engineers. St. Joseph, Mich. USA.
- Beeny, J. N. and D. C. P. Khoo. 1970. Preliminary investigations into the performance of different shaped blades for rotary tillage of wet rice soil. *Journal of Agricultural Engineering Research*, 15(1): 27-33.
- Bukhari, K. H., S. Bukhari, M. M. Leghari, and M. S. Memon. 1996. The effect of speed and rear shield on the performance of rotary tiller. *Agricultural Mechanization in Asia, Africa and Latin America*, 27(2): 9-14.
- Hendrick, J. G. and W. R. Gill. 1971a. Rotary tiller design parameters: Part I - Direction of rotation. *Transactions of the ASAE*, 14(4): 669-674, 683.
- Hendrick, J. G. and W. R. Gill. 1971b. Rotary tiller design parameters: Part II –Depth of tillage. *Transactions of the ASAE*, 14(4): 675-678.
- Manian, R. and K. Kathirvel. 2001. Development and evaluation of an active-passive tillage machine. *Agricultural Mechanization in Asia, Africa and Latin America*, 32(1): 9-18.
- Marenya, M. O. 2009. Performance characteristics of a deep tilling rotavator. Unpublished PhD. thesis. Department of Civil and Biosystems Engineering, University of Pretoria. Pretoria, South Africa.
- Marenya, M. O. and H. L. M. du Plessis. 2006. Torque Requirements and Forces Generated by a Deep Tilling Down-Cut Rotary Tiller. ASABE Paper No. 061096. Paper presented at the ASABE Annual International Meeting (AIM), Portland, Oregon, USA in July.
- Marenya, M. O., H. L. M. du Plessis, and N. G. Musonda. 2003. Theoretical force and power prediction models for rotary tillers –a review. *Journal of Engineering in Agriculture and the Environment* 3(1): 1-10.
- Prasad, J. 1996. A comparison between a rotavator and conventional tillage equipment for wheat-soybean rotations on a vertisol in Central India. *Soil & Tillage Research*, 37 (1996): 191-199.
- Salokhe, V. M. and N. Ramalingam. 2001. Effects of direction of rotary tiller on properties of Bangkok clay soil. *Soil & Tillage Research*, 63(1): 64-74.
- Salokhe, V. M., M. Hanif, and M. Hoki. 1993. Effect of blade type on power requirement and puddling quality of a rotavator in wet clay. *Journal of Terramechanics*, 30(5): 337-350.
- Shibusawa, S. 1993. Reverse-rotational rotary tiller for reduced power requirements in deep tillage. *Journal of Terramechanics*, 30(3): 205-217.
- Sineokov, G. N. and I. M. Panov. 1978. Theory and calculation of soil working machines. Translated for the U.S Department of Agriculture, Agricultural Research Service and the National Science Foundation, Washington D.C.
- Shinners, K. J., J. M. Wilkes, and T. D. England. 1993. Performance characteristics of tillage machine with active-passive components. *Journal of Agricultural Engineering Research*, 55: 277-297. ■■

# Geometric Design Characterisation of Ventilated Multi-scale Packaging Used in the South African Pome Fruit Industry

Tarl Berry

Postgraduate Student  
Postharvest Technology Research Laboratory,  
South African Research Chair  
in Postharvest Technology,  
Stellenbosch University  
SOUTH AFRICA

Mulugeta A. Delele

Postdoctoral Fellow  
Postharvest Technology Research Laboratory,  
South African Research Chair  
in Postharvest Technology,  
Stellenbosch University  
SOUTH AFRICA

Henk Griessel

Tru-Cape Packhouse, Grabouw,  
SOUTH AFRICA



Umezuruike Linus Opara

Research Professor and DST/NRF Research Chair  
Postharvest Technology Research Laboratory,  
South African Research Chair in Postharvest Technology,  
Stellenbosch University, SOUTH AFRICA  
opara@sun.ac.za

## Abstract

Ventilated corrugated cartons are the primary types of packaging used in export shipment of fresh fruit, including apples and pears. The use of inappropriately ventilated packaging can result in cooling heterogeneity and incidence of physiological disorders during cold chain handling of fresh fruit, and in extreme cases, mechanical damage of packaging and fruit. A survey on the types of ventilated packaging in South Africa showed that eleven different corrugated fibreboard carton designs were used in export handling of pome fruit, with Mk4 and Mk6 cartons accounting for the majority of those used apple (48 %) and pear (57 %), respectively. Each package design type is often used in several dimensional formats to accommodate different fruit sizes and market requirements. Overall, the different carton designs can be classified into

‘Display’ and ‘Telescopic’ packages, with four stacking configurations commonly used to palletise the cartons. Total ventilated area (TVA) per carton varied between 1.92 and 8.81 %, with average of 3.80 and 4.44 % for display and telescopic designs, respectively. Improper vent positioning on some packages may result in non -alignment of ventilation in stacked pallets, which in turn may alter airflow patterns during forced-air cooling.

## Introduction

Fruit are living entities that deteriorate in quality as they respire and transpire, leading ultimately to senescence (Salisbury & Ross, 1992; Brosnan & Sun, 2001). Temperature is the most important factor in moderating fruit deterioration as it regulates the rates of biological reaction occurring inside fruit (Nel-

son, 1978; Ravindra & Goswami, 2008). Precooling is, therefore, used to reduce the temperature and thereby extend storage life of harvested fruit. Forced air cooling (FAC) is acknowledged as the most common precooling technique in the fruit industry to remove excess heat (De Castro, Vigneault, & Cortez, 2004a; Zou, Opara, & McKibbin, 2006) and is often performed after fruit packaging (Talbot & Baird, 1990; Ladaniya & Singh, 2000). Heat transfer between fruit and the cooling medium (cold air) is largely facilitated by ventilation holes in the walls of the stacked cartons, which allows airflow penetration through a pallet stack. During FAC, ventilation holes in the packaging should facilitate a homogenous cooling pattern throughout a stack of cartons by directing uniform airflow through the stack. The uniformity of airflow inside the package containing fruit is significantly affected by the

size and distribution of ventilation holes on the carton wall (de Castro *et al.*, 2004a). Cooling efficiency is, however, affected by vent position and size, while the effect of the vent shape, is significantly influenced by several factors, such as the width of opening, position and container contents (Kader, 2002; Vigneault & Goyette, 2002). Carton strength is also significantly affected by the presence, size and shape of ventilation holes (Singh *et al.*, 2008; Han & Park, 2007). The addition of ventilation holes should therefore not compromise the mechanical strength of the carton (Vigneault & Goyette, 2002; De Castro, Vigneault, & Cortez, 2004b; Vigneault & de Castro, 2005).

In order for a ventilated carton to function at optimum, cartons should have sufficient mechanical strength to protect the fruit (Robertson, 2006; Vigneault, Goyette, & De Castro, 2006), while supplying sufficient ventilation to maintain the cold chain. The ventilation should include holes at both the top and bottom, depending on design type (Vigneault & Goyette, 2002; De Castro *et al.*, 2004b). According to Kader, (2002), a total vent area (TVA) of 5-6 % for fibreboard cartons is a good compromise between strength and ventilation area. However, de Castro *et al.* (2005) showed that TVA between 8 and 16 % results in the best air cooling efficiency. In earlier studies, the authors showed that TVA < 25 % significantly restricted airflow in ventilated containers (Vigneault & Goyette, 2002) However, such large open areas on the package could compromise the structural integrity of the package, especially paper-board based packaging.

Ventilated cartons are the most commonly used type of packaging used in the fruit industry. To meet the wide range of export and domestic market demands, different design of packaging are used resulting in geometrical configura-

tions and sizes (Opara & Zou, 2007; Pathare, Opara, Vigneault, Delele, & Al-Said, 2012). Despite the availability of numerous designs, it has been reported that many packaging types used in the fruit industry are not effective in promoting fast and uniform cooling (Ferrua & Singh, 2007). Several authors have recommended that new packaging systems should be thoroughly evaluated to optimise ventilation design and ultimately improve cooling (Vigneault *et al.*, 2006; Vigneault, Thompson, & Wu, 2009; Thompson, Mejia, & Singh, 2010; Pathare *et al.*, 2012). In addition to improving technical (thermal and mechanical) efficiency of packaging, rising energy costs (Sebitosi, 2008) and the need to reduce packaging and fruit carbon footprint (Thompson *et al.*, 2010) have heightened the need to re-examine the role of ventilated package design used in the agricultural industry. A wide range of ventilated packaging designs are used in the global postharvest handling and distribution of fruit. However, little is known about the geometric and ventilation characteristics of existing packages used in the industry to assist in formulating future designs to meet the technical and socio-environmental requirements of packaging. The objective of this study was, therefore, to quantify the geometric design characteristics of ventilated packaging used in the South African pome fruit (apples and pears) industry.

## Material and Methods

### Survey Methodology

The survey was carried by collecting samples of all available apple and pear cartons from major pack houses in two major pome fruit growing areas (Grabouw and Ceres) in the Western Cape Province, South Africa, as well as from the fresh produce section of major supermarkets in the province. The

survey was performed between January and July 2012 and the Western Cape Province was chosen at the study area because it accounts for over 92 % of apples and pear production in South Africa (PPECB, 2013a).

Each package was examined based on three broad geometric characteristics: a) carton dimensions (length and width); b) ventilation (size and number of holes); and c) presence of internal packaging (polyethylene bags (polyliner), trays, punnets or thrift bags).

### Data Analysis

Data on the usage of different cartons for fruit export were collected from the Perishable Products Export Control Board (PPECB, 2013b). Each package design was linked to a local 'pack code' which in turn is linked to a 'Global Trade Item Number' of fruit exports. The descriptive capabilities of the 'pack code' was found to be limited while classifying the packages, given that the same code may be used for different variations of similar carton designs produced by different packaging production companies. In addition, the 'pack code' may also be dissimilar for the same carton design if one of them contained differing internal packaging. Up to five samples of each carton design were examined and measured to verify the dimensions reported. Due the lack of differences in geometric characteristics of each type of carton, standard deviations of the data are not applicable.

## Results and Discussion

### Packaging Export Statistics

The main types of packaging used to export apples (**Table 1**) and pears (**Table 2**) from South Africa to various markets between 2008 and 2012 were obtained from export statistics (PPECB, 2013b). The data is clearly indicative of a market-driven

**Table 1** Cartons of apples exported between 2008 and 2012 by carton type and region (PPECB, 2013b)

	Africa	America	Atlantic Ocean Isle	Australia	C/Europe	F/East & Asia	Indian Ocean Island	M/East & Mediterranean	Unknown	Russia	United Kingdom	Total (%)
Bushel	41,662	23,046	0	0	15,793	556,139	42,217	623	1,767	0	2,993	0.61
Econo-D	357,224	450	0	0	341,579	22,186	15,752	215,224	16,151	5,643	66,007	0.93
Econo-T	107,555	3,702	0	216	1,219,051	58,707	18,546	127,153	9,434	28,146	268,021	1.65
Micro-D	1,129	0	0	0	0	0	140	115	0	0	75	0.00
Jumble	200,322	0	0	0	4,896	0	0	0	0	0	820	0.19
Mini-mk9	3,363	0	0	0	3,641	0	0	185	0	0	52,739	0.05
Mini-T	8,019	0	0	0	40,617	8,638	0	52,664	0	46	2,252	0.10
Mk4	15,429,298	283,275	3,077	1,972	19,063,127	11,055,384	610,483	4,226,980	496,208	315,350	2,163,004	48.20
Mk6	645,613	11,824	414	20	2,025,115	149,666	22,747	1,198,346	81,847	402,308	184,527	4.24
Mk7	7,605	430	0	0	285,406	10,271	0	12,428	20	920	284,747	0.54
Mk9	109,317	72,781	0	2	6,567,388	193,666	996	74,904	206,778	24,159	16,800,338	21.61
Other	2,533,227	67,924	62	0	4,239,058	1,508,911	35,286	1,025,067	35,351	85,689	14,528,043	21.61
Plastic	0	0	0	0	20,306	9,378	0	0	10,365	0	241,765	0.25
Total (%)	17.47	0.42	0.00	0.00	30.39	12.19	0.67	6.23	0.77	0.77	31.08	

**Table 2** Cartons of pears exported between 2008 and 2012 by carton type and region (PPECB, 2013b)

	Africa	America	Atlantic Ocean Isle	Australia	C/Europe	F/East & Asia	Indian Ocean Island	M/East & Mediterranean	Unknown	Russia	United Kingdom	Total (%)
Bushel	56	0	0	0	11,486	4,050	0	0	0	0	480	0.02
Econo-D	30,479	0	0	0	80,753	3,284	8	217	770	0	13,065	0.17
Econo-T	15,293	0	0	0	402,153	6,217	2,019	1,806	12,204	1,504	34,118	0.62
Micro-D	14,947	0	0	0	6,530	0	20	34	0	0	36	0.03
Jumble	2,363	0	0	0	0	0	0	63	0	0	0	0.00
Mini-mk9	1	0	0	0	43,857	0	70	13,636	0	0	10,070	0.09
Mini-T	62	280	0	0	314,732	1,095	700	0	16,585	80	4,290	0.44
Mk4	39,823	1,616	74	0	372,419	35,083	1,980	4,651	75,010	3,291	14,142	0.71
Mk6	1,322,479	1,077,697	823	17,973	28,639,825	4,035,054	261,231	2,655,450	1,410,063	2,023,905	2,018,872	56.63
Mk7	22,401	103,144	11,515	0	14,989,115	186,026	11,342	197,717	434,446	34,475	1,020,520	22.16
Mk9	144,201	39,715	0	75	5,144,087	25,340	84	16,861	434,096	8,657	2,595,403	10.96
Other	385,864	21,683	30	226	4,087,668	933,648	14,091	528,540	41,677	220,133	0	8.12
Plastic	15	0	0	0	4,745	0	0	0	975	0	28,392	0.04
Total (%)	2.58	1.62	0.02	0.02	70.49	6.81	0.38	4.45	3.16	2.99	7.48	

package design and deployment strategy. From a design perspective, each package type may be used for both apples and pears; however, due to practical limitations such as retail shelf layout and limitation of package weight and regional market preferences, certain package types are clearly more favoured for a certain fruit type. For instance, the Central Europe (C/Europe) and United Kingdom regions were responsible for 95 % of the Mk7 and Mk9 carton exports, while there was a relatively even distribution for the rest of the package designs. This high preference can be explained by many of the supermarkets in these areas making use of retail shelves specifically designed to accommodate the Mk7 and Mk9 (600 × 400 mm).

The two primary telescopic package types are Mk4 and Mk6 cartons, both designed to facilitate high density packaging of pome fruit. These two cartons were used for 48 and 4

% of total apple exports, respectively, and < 1 and 57 % of pear exports, respectively. This significant difference in carton use can be attributed to the higher density of pears (approx. 1.05 kg/L) compared to apples (approx. 0.86 kg/L). Although the Mk4 offers a higher packing density of fruit, the average mass of packed fruit is 18 kg of apples and 22 kg of pears. The large weight of a 22 kg carton is generally considered high for human lifting, resulting in more preference for 12 kg mini-MK6 pear cartons.

Similar observations were noted with the two most widely used 'Display cartons' (Mk7 and Mk9). The Mk7 package design, which represents 22 and < 1 % of total pear and apple export cartons is used primarily with a single tray of fruit. On the other hand, the Mk9 which has capacity for two trays represented 22 and 11 % of apple and pear carton exports, respectively. In addition, the higher height of Mk9 package

allows for convenient packaging of thrift bags and punnets, and hence making the package design popular for handling and marketing of both apples and pears.

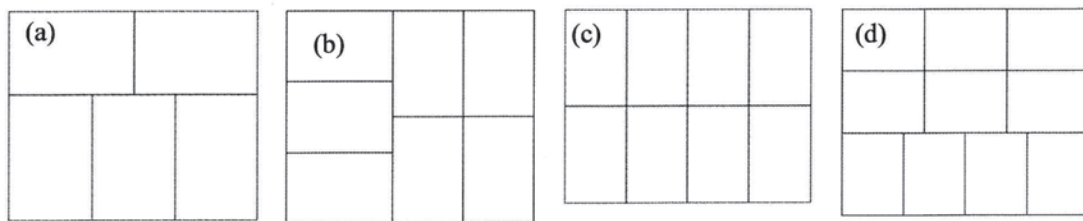
### Packaging Formats and Types

The survey identified four stack configurations as shown in **Fig. 1**. These configurations are based on the standard 1.2 × 1.0 m export pallet and the 1.2 × 0.9 m (**Fig. 1c**) pallet which is used predominantly in the local market.

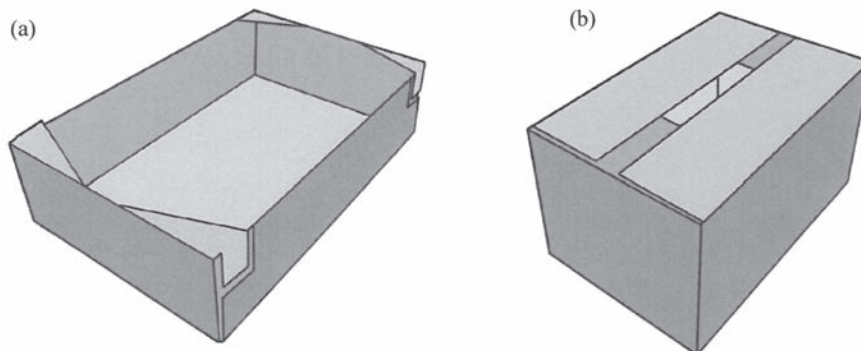
There are several companies in the Western Cape Province (South Africa) producing numerous carton designs, which is largely a market-driven process. Overseas and local markets will place an order for specific type of fruit packed inside specific package design to meet the requirements for their handling systems and marketing logistics, including transportation using freight containers.

Two major distinct carton de-

**Fig. 1** Pallet stacking arrangements showing a) 5, b) 7, c) 8 and d) 10 cartons per layer



**Figs. 2 and 3**-D outline of a) Display/ (0773-M) and b) Telescopic/ (0200-M/A) carton designs





signs were identified in the survey, namely the display (**Fig. 2a**) and the Telescopic designs (**Fig. 2b**). Telescopic cartons are commonly used for packaging of fruit in layers or bulk, allowing fruit to be re-packaged or placed in a heap at the point of retail. Display cartons on the other hand, serve a communication function by allowing the whole package to be placed directly on the shelf at the point of retail. The construction of a fibreboard carton, irrespective of its size and ventilation can be described according to 'The International Fibreboard Class Code' (IFCC) document, which uses a simple code to describe the construction design (FEFCO & ESBO, 2007). Under the IFCC fibreboard box categories the construction of display cartons follows the 'Ready-glued cases' category (code 0773-M design) and 'Folder-type' (code 0432-M design). The telescopic cartons follow the 'Telescope-type boxes' category (code 0200-M/A). Within the two categories, a total of twenty carton designs were identified during the survey, and on closer examination, there were further classified into eleven distinct types of carton as shown in **Table 3**.

The Mark 7 (Mk7) and Mark 9 (Mk9) cartons are very similar in shape and vent design. However, the primary difference is that Mk7 is designed for a single layer of fruit while Mk9 is designed to hold a double layer of fruit. The additional height of the Mk9 carton (39 > 91 mm) allows for the use of internal packaging, such as thrift bags and punnets, which make it popular in the export of both apples and pears, whereas the Mk7 is almost entirely used for pear exports.

The Mini-Mk9 and Econo-D cartons are both display carton designs, which are used primarily on the local market, although a small number of exports do occur. The Mini-Mk9 carton is frequently used at local convenience stores near motor-vehicle refuelling stations. Trays are

**Table 3** Generalized design characteristics of apple and pear cartons

Carton name	Open Display						Telescopic				
	Micro-D	Mini-Mk9	Mark 9	Mark 7	Econo-D	Econo-T	Bushel	Mark 6	Mark 4	Jumble	Mini-T
Pack code (part of GTIN)	A02C, B02C, C02C	M05D, M06D	A12T, A12D, B12D, C12D	A06D, B06T, B06D, C06T, C06D	E12D, T12D	E12T, T12T	M22T	M12T	M18T, P15T	J11T, J10T	M07T
International Fibreboard class code	0432-M	0773-M	0773-M	0773-M	0773-M	0200-M/A	0200-M/A	0200-M/A	0200-M/A	0200-M/A	0200-M/A
Dimensions (mm)	Length 300 Breadth 79 Height	400 300 150	600 400 139	600 400 91	460 300 229	460 300 238	500 330 339	400 300 220-275	500 330 287	350 300 228	400 300 142
Length-wise surface area (mm <sup>2</sup> )	Total area 3,214 Vent area 10.17	60,000 2,094 3.49	83,100 3,721 4.48	54,600 5,599 10.25	105,340 1,145 1.09	109,480 3,680 3.36	169,500 5,073 2.99	97,200 5,163 5.31	143,625 5,448 3.79	79,625 3,520 4.42	56,800 5,880 10.35
Breadth-wise surface area (mm <sup>2</sup> )	Total area 220 Vent area 0.93	45,000 0 0.00	55,400 49 0.09	36,400 0 0.00	68,700 2,193 3.19	71,400 1,473 2.06	111,870 3,598 3.22	72,900 2,050 2.81	94,793 3,758 3.96	68,250 2,086 3.06	42,600 2,880 6.76
Total carton vent area (%)	6.21	1.99	2.72	6.15	1.92	2.85	3.08	4.24	3.86	3.79	8.81
Internal packaging (number of trays plus other materials)	1	2 or 2+Poly-liner, or thrift-bags or punnets	2 or 2+Poly-liner or thrift-bags or punnets	1 or 1+Poly-liner or thrift-bags or punnets	thrift-bags	thrift-bags	6 or 6+Poly-liner	4 or 4+Poly-lineror Thrift bags	4 or 4+Poly-liner	Loose	2 or 2+Poly-liner,
Cartons per a pallet layer	10	10	5	5	8	8	7	10	7	10	10

regularly used in the Mini-Mk9 to enable consumer purchase of individual fruit as a 'snack food'.

The Econo-D and Econo-T have been designed to accommodate the different transport requirements of the local South African market. This entails the use of thinner corrugated fibreboard and a different package size to accommodate different pallet sizes and smaller transport distances. According to industry experience, these characteristics reduce the resistance of the palletized stack to compression damage. However, given the significantly shorter transport duration and the competitive nature of the local market for low cost fruit, the reduced strength of the carton is validated as it might

result in a situation where a minor decrease in quality is acceptable if there is a significant reduction in cost. The Econo-T is the telescopic version of the Econo-D carton. The Econo-T design is also used predominantly with thrift-bags of fruit in the local market.

The Mark 11 (Mk11) and Bushel package designs are used for high density packaging of pome fruit, with two and six trays, respectively, while the Mk4 and Mk6 designs hold four trays of fruit. The Mini-T cartons are telescopic designs used in conjunction with two trays and sometimes with a polyliner bag. The Mini-T is half the height (and capacity) of the Mk6 carton and is used for both apple and pear export.

This design offers a larger degree of physical protection to the fruit by making use of a larger package-to-fruit ratio of packaging than the Mk6 and Mk4 cartons.

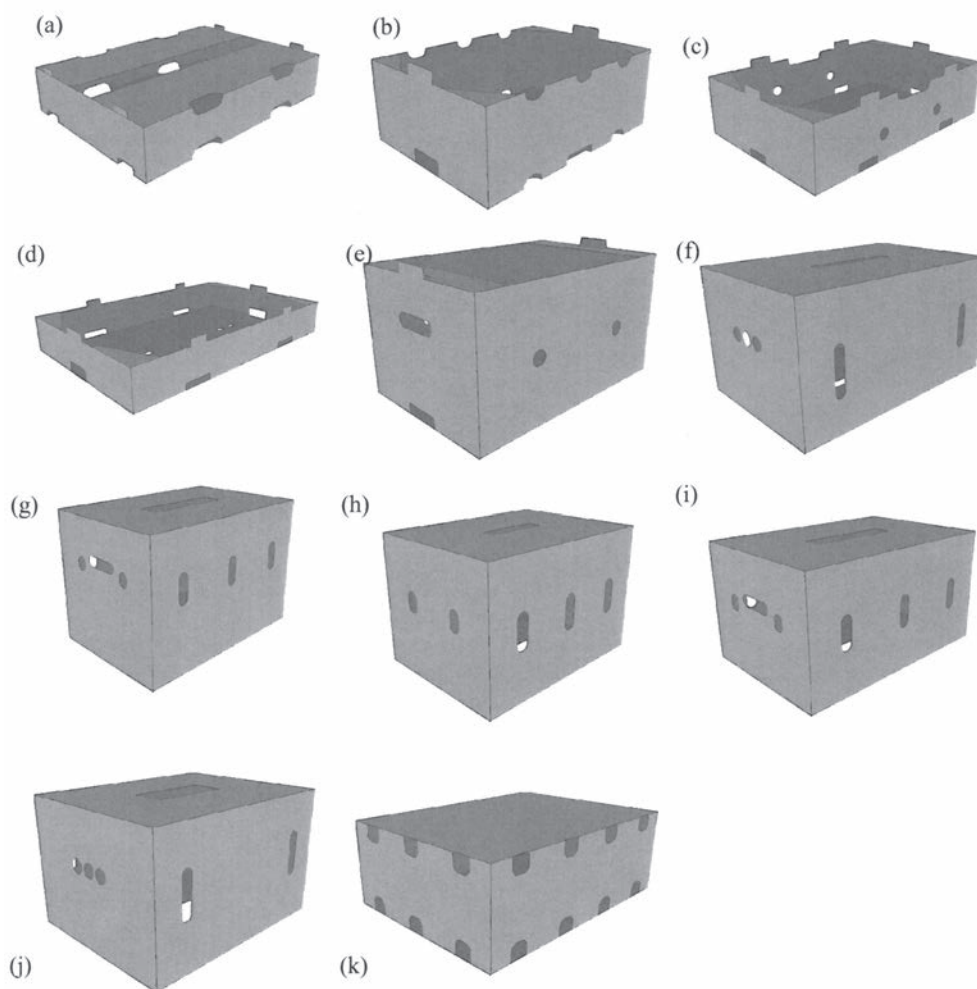
The jumble carton is a high density bulk packaging used primarily for apples where fruit are packed loose inside the carton. The carton is almost exclusively used for the transport of lower grade apples in the local informal market, as well as for export to other African countries. The reduction in packaging size reduces the overall packaging cost. **Table 3** shows the geometrical size and ventilation area of the different types of packaging.

### Internal Packages

Several types of internal packaging are used in the pome fruit industry, resulting in multi-scale ventilated packaging. Internal packaging can play both an aesthetic and functional role in the postharvest handling of fruit. The tray was the most commonly observed internal packaging and is either produced from polyethylene or pulp paper and mostly used to hold fruit inside telescopic cartons (Holt & Schoorl, 1984).

Polyliner bags are also used inside apple and pear, by packaging them inside the carton surrounding the trays and fruit. Polyliner bags are used in Telescopic cartons and Display cartons in combination with trays. The primary functions of polyliner bags are to modifying the moisture, oxygen, carbon dioxide or volatile gas concentrations surrounding fruit (Shorter, Scott, Ward, &

**Fig. 3** D outlines of a) Micro-D, b) Mini-Mark9, c) Mark9, d) Mark 7-D, e) Econo-D, f) Econo-T, g) Bushel, h) Mark 6, i) Mark 4, j) Jumble and k) Mini-T



Best, 1992; Geeson, Genge, & Sharples, 1994; Linke & Geyer, 2013). Polyliner bags also present a physical barrier between the fruit and pathogens in the surrounding air. Three predominant film thicknesses found were 20, 37.5 and 60  $\mu\text{m}$ .

Thrift bags and punnets are also used in pome fruit packaging. These packages allow several fruit to be placed inside a bag or punnet and then placed into a carton to facilitate handling and retailing marketing (Vigneault *et al.*, 2009). In addition to the above types of inner packaging, shrivel sheets, riffled paper, sponge sheets, jiffy pads and bubble pack sheets are often used as mechanical insulators between fruit and the carton top wall to prevent physical damage to fruit from fruit-carton contact. Bubble pack sheets were the most commonly observed type used in pome packaging.

The effects of multi-scale packaging on fruit quality and cooling rate have been reported. For instance, (Ngcobo, Delele, Opara, Zietsman, & Meyer, 2012) showed that the presence of internal packaging (such as polyliner bags) in multi-scale packages of table grapes restricted airflow through the package during forced air cooling (FAC). The results showed that polyliner bags contributed to 40 and 83 % of the total pressure drop of package for micro-perforated and non-perforated liner films, respectively. In addition, the use of bunch carry bags (which are similar to thrift bags) accounted for 2.43 to 12.58 % of the total pressure drop.

### Ventilation Characteristics

The ventilation characteristics of the eleven major carton types identified are displayed in Table 3. Mk4, Mk6, Mk11 and Bushel cartons have oblong vent holes in accordance with the recommendation by Han & Park, (2007). The ventilation configuration of Mini-T, however, follows the recommendation of (Thompson, Mitchell, & Kasmire, 2002) that 5

to 6 % side wall ventilation should be used as a compromise between mechanical strength and airflow penetration. The, Econo-T, Econo-D and Jumble cartons also have mainly oblong vents; however, many side walls were found to have circular shape holes, usually with a diameter of 26 mm. Finally, the Mk7 and Mk9 cartons, which are relatively low in depth, have circular holes (26 mm) and/or large cavities along the top edge of the carton (width). Several slot holes were also present, although during stacking, these would be obstructed by the corresponding tabs of the carton below.

Many of the cartons are stacked in configurations which allow both the carton length and breadth to align perpendicular to the direction of airflow (**Fig. 1**), highlighting the importance of ensuring that both sides of the carton are ventilated. **Table 3** shows that total carton ventilation varied considerably between 1.92 % (Econo-D, open display) and 8.81 % (Mini-T, telescopic). Mean side wall (length-wise) ventilation area 5.04 and 5.90 %, respectively, for telescopic and display designs, which is within the range recommended by Thompson *et al.* (2002). The Mini-Mk9, Mk7 and Mk9 packages have no ventilation along the breadth (shortest side of the carton). This resulted in lower mean carton breadth side vent area of 0.84% for display cartons compared with telescopic designs (3.65 %).

Due to the different stacking configurations, these cartons will not have complete ventilation alignment in stacking types a, b and d (**Fig. 1**) in both directions (length and width). The lack of ventilation alignment will result in large pressure drops (Vigneault, Markarian, & Goyette, 2004) and poor airflow rates during forced air cooling (FAC) and therefore contributing to ineffective precooling of fruit (Kader, 2002). Computational fluid dynamic modelling of airflow, heat and mass transfer inside ventilated

multi-scale packaging of spherical objects showed the stacking patterns have considerable influence on airflow patterns and fruit cooling rates (Delele *et al.*, 2008).

De Castro, Vigneault, & Cortez (2005b) recommended an open area of 8-16 % for effective cooling and Kader (2002) recommended 5-6 %. None of the commonly used pome fruit cartons was within the range of ventilation area recommended by de Castro *et al.* (2005a), while only the Mini-T has ventilation area within the range recommended by Kader (2002). It should be noted, however, that these recommended vent open areas reported in the literature were based on experimental analysis of specific package designs for specific types of fruit. This makes it difficult to compare different designs used to handle different types of fruit in different supply chains. More research is required in this area, including the application of recent advances in computational fluid dynamics and finite element modelling (Pathare *et al.*, 2012).

## Conclusions

Appropriate ventilated packaging is an essential tool in the process of postharvest management of fresh horticultural produce such as fruit. In addition, good temperature control in the cold chain is vital to maintain fruit quality and increase the duration of fruit storage times in postharvest systems. The survey of ventilated package geometrical designs in South Africa showed that eleven corrugated fibreboard carton designs are predominantly used in commercial handling and marketing of pome fruit. Furthermore, these carton designs can be packaged with several types of internal packaging, including trays, polyethylene liner bags, thrift bags and punnets.

The different types of package used to handle apples and pears can be divided into 'Display' and 'Tele-

scopic' designs. Display cartons, through the use of internal packaging such as thrift bags and punnets, offer retail ready pre-packaged fruit, and therefore add additional marketing value to the carton. Telescopic cartons, on the other hand, offer high density fruit packaging during shipping; however, they usually require repacking at the retailer. For the telescopic carton designs, the Mk4 made up 48 % of apple cartons and Mk6 design accounted for 58 % of pear cartons used in fruit export. For display cartons, 22 % of apple and pear export cartons used were Mk9 and Mk7, respectively. The ventilation area per carton varied between 1.92 and 8.81 %., with average of 3.80 and 4.44 % for display and telescopic designs, respectively. The practical implications of these variable vent characteristics on carton cooling and mechanical performance are not well known and no evidence of a standardised approach to optimise vent design was found during the study. More research is recommended in this area.

#### Acknowledgement

This work is based upon research supported by the South African Research Chairs Initiative of the Department of Science and Technology and National Research Foundation. The financial support of the South African Postharvest Innovation Programme (PHI) through the award of a research project on "Packaging of the Future" is gratefully acknowledged.

#### REFERENCES

- Brosnan, T. and D. W. Sun. 2001. Precooling techniques and applications for horticultural products –a review. *International Journal of Refrigeration*, 24(2): 154-170.
- De Castro, L. R., C. Vigneault, and L. A. B. Cortez. 2004a. Container opening design for horticultural produce cooling efficiency. *Journal of Food, Agriculture and Environment*, 2(1): 135-140.
- De Castro, L. R., C. Vigneault, and L. A. B. Cortez. 2004b. Effect of container opening area on air distribution during precooling of horticultural produce. *Transactions of the ASAE*, 47(6): 2033-2038.
- De Castro, L. R., C. Vigneault, and L. A. B. Cortez. 2005a. Effect of container openings and air-flow rate on energy required for forced-air cooling of horticultural produce. *Canadian Biosystems Engineering*, 47, 1-9.
- De Castro, L. R., C. Vigneault, and L. A. B. Cortez. 2005b. Cooling performance of horticultural produce in containers with peripheral openings. *Postharvest Biology and Technology*, 38(3): 254-261.
- Delele, M. A., E. Tijskens, Y. T. Atalay, Q. T. Ho, H. Ramon, B. M. Nicolai, and P. Verboven. 2008. Combined discrete element and CFD modelling of airflow through random stacking of horticultural products in vented boxes. *Journal of Food Engineering*, 89(1): 33-41.
- FEFCO and ESBO. 2007. International fibreboard case code. (p. 71). Belgium: FEFCO.
- Ferrua, M. J. and R. P. Singh. 2007. Modelling airflow through vented packages containing horticultural products. In D. W. Sun (Ed.), *Computational Fluid Dynamics in Food Processing* (pp. 650-679). Florida: CRC.
- Geeson, J. D., P. M. Genge, and R. O. Sharples. 1994. The application of polymeric film lining systems for modified atmosphere box packaging of English apples. *Postharvest Biology and Technology*, 4(1-2): 35-48.
- Han, J. and J. M. Park. 2007. Finite element analysis of vent/hand hole designs for corrugated fibreboard boxes. *Packaging Technology and Science*, 20(1): 39-47.
- Holt, J. and D. Schoorl. 1984. Package protection and energy dissipation in apple packs. *Scientia Horticulturae*, 24(2): 165-176.
- Kader, A. A. 2002. *Postharvest Technology of Horticultural Crops* (3rd ed., p. 353). Davis, California: University of California, Department of Agriculture and Natural Resources, Cooperative Extens.
- Ladaniya, M. S. and S. Singh. 2000. Influence of ventilation and stacking pattern of corrugated fibre board containers on forced-air pre-cooling of "Nagpur" Mandarins. *Journal of Food Science and Technology*, 37(3): 233-237.
- Linke, M. and M. Geyer. 2013. Condensation dynamics in plastic film packaging of fruit and vegetables. *Journal of Food Engineering*, 116(1): 144-154.
- Nelson, K. E. 1978. Pre-cooling-its significance to the market quality of table grapes. *International Journal of Refrigeration*, 1(4): 207-215.
- Ngcobo, M. E. K., M. A. Delele, U. L. Opara, C. J. Zietsman, and C. J. Meyer. 2012. Resistance to airflow and cooling patterns through multi-scale packaging of table grapes. *International Journal of Refrigeration*, 35(2): 445-452.
- Opara, U. L. and Q. Zou. 2007. Sensitivity analysis of a CFD modelling system for airflow and heat transfer of fresh food packaging: Inlet air flow velocity and inside-Package configurations. *International Journal of Food Engineering*, 3(5), Article 16.
- Pathare, P. B., U. L. Opara, C. Vigneault, M. A. Delele, and F. A.-J. Al-Said. 2012. Design of Packaging Vents for Cooling Fresh Horticultural Produce. *Food and Bioprocess Technology*, 5(6): 2031-2045.
- PPECB. 2013a. SEA Exports - Pome: Products Per Load Port. Paarl, South Africa: Perishable Products Export Control Board.
- PPECB. 2013b. Packaging and destination data for sea-exports between 2008 and 2012 in South Africa. Paarl, South Africa: Perishable Products Export Control



- Board.
- Ravindra, M. R., and T. K. Goswami. 2008. Comparative performance of precooling methods for the storage of mangoes (*Mangifera indica* L. CV. amrapali). *Journal of Food Process Engineering*, 31(3): 354-371.
- Robertson, G. L. 2006. *Food Packaging, Principles and Practices* (2nd ed., p. 550). FL: CRC Press: Boca Raton.
- Salisbury, F. B. and C. W. Ross. (Eds.) 1992. *Plant Physiology* (4th ed., p. 381). Belmont Calif: Wadsworth Publishing Company.
- Sebitosi, A. B. 2008. Energy efficiency, security of supply and the environment in South Africa: Moving beyond the strategy documents. *Energy*, 33(11): 1591-1596.
- Shorter, A. J., K. J. Scott, G. Ward, and D. J. Best. 1992. Effect of ethylene absorption on the storage of Granny Smith apples held in polyethylene bags. *Postharvest Biology and Technology*, 1(3): 189-194.
- Singh, J., E. Olsen, S. P. Singh, J. Manley, and F. Wallace. 2008. The Effect of ventilation and hand holes on loss of compression strength in corrugated boxes. *Journal of Applied Packaging Research*, 2(4): 227-238.
- Talbot, M. T. and C. D. Baird. 1990. Evaluating Commercial Forced-Air Precoolers. *Proceedings of the Florida State Horticultural Society*, 103, 218-221.
- Thompson, J. F., D. C. Mejjia, and R. P. Singh. 2010. Energy use of commercial forced-air coolers for fruit. *Applied Engineering in Agriculture*, 26(5): 919-924.
- Thompson, J. F., F. G. Mitchell, and R. F. Kasmire. 2002. Cooling Horticultural Commodities. In A. A. Kader (Ed.), *Postharvest Technology of Horticultural Crops* (3rd ed., p. 101). Davis, California: University of California, Department of Agriculture and Natural Resources, Cooperative Extension.
- Vigneault, C. and L. R. De Castro. 2005. Produce-simulator property evaluation for indirect airflow distribution measurement through horticultural crop package. *Journal of Food, Agriculture and Environment*, 3(2): 93-98.
- Vigneault, C. and B. Goyette. 2002. Design of plastic container opening to optimize forced-air precooling of fruits and vegetables. *Applied Engineering in Agriculture*, 18(1): 73-76.
- Vigneault, C., B. Goyette, and L. R. De Castro. 2006. Maximum slat width for cooling efficiency of horticultural produce in wooden crates. *Postharvest Biology and Technology*, 40(3): 308-313.
- Vigneault, C., N. R. Markarian, and B. Goyette. 2004. Pressure drop during forced-air ventilation of various horticultural produce in containers with different opening configurations. *Transactions of the ASAE*, 47(3): 807-814.
- Vigneault, C., J. F. Thompson, and S. Wu. 2009. Designing container for handling fresh horticultural produce. In: Benkeblia, N. and Shiomi, N. (eds.) –*Postharvest Technologies for Horticultural Crops*. Vol. 2, Research Signpost, Kerala, India, Chapter 2, pp. 25-47.
- Zou, Q., U. L. Opara, and R. McKibbin. 2006. A CFD modeling system for airflow and heat transfer in ventilated packaging for fresh foods: I. Initial analysis and development of mathematical models. *Journal of Food Engineering*, 77(4): 1037-1047.

■ ■



# Nondestructive Approach to Evaluate Defects in Elements of Agricultural Machinery



by  
Nur-A-Alam  
Graduate Student,  
qoxia@yahoo.com



Rostom Ali  
Associate Professor,  
engr\_rustomfpm@yahoo.  
com



Murshed Alam  
Professor,  
murshedalambau@yahoo.  
com

Department of Farm Power and Machinery, Bangladesh Agricultural University, Mymensingh-2202, Bangladesh

## Abstract

This study was conducted to inspect defects nondestructively in different parts of agricultural machinery using the developed DC four-point probe voltage drop technique. Inspection is carried out by injecting currents between the outer probes in the specimen to be tested and measuring the arising electrical voltage drop between two inner probes placed on its surface. A DC four-point probe voltage drop technique was designed and developed based on locally available materials. The presence of a defect generally increases the resistance in current flow and hence increases the measured voltage drop. Artificial cracks were made in different samples and voltage drops were measured to verify the developed experiment. Five, ten and fifteen amperes of current was applied from a DC 12V battery into three samples: Mild Steel (MS) flat bar, Stainless Steel (SS) flat bar and Carbon Steel (CS) flat bar to represent as materials of the agricultural machinery parts. Experimental and calculated voltage drop values are very close to one another. This study observed that the average resistivity of MS flat bar, SS flat bar and CS flat bar were

$1.33 \times 10^{-4} \Omega\text{-m}$ ,  $3.91 \times 10^{-4} \Omega\text{-m}$  and  $1.73 \times 10^{-4} \Omega\text{-m}$ , respectively in crackfree condition. Two simple calculators were also made using C++ programming to calculate voltage drop and resistivity.

**Keywords:** Nondestructive Testing (NDT), NDT in Agricultural Machinery, DC Voltage Drop in Agricultural Machinery

## Introduction

Farm machineries are major elements of farm mechanization in Bangladesh. Timeliness in farm operations is a crucial factor for successful agricultural operations. The failure of important parts like PTO/propeller shaft, spline shaft, tine/blade etc. of farm machineries espe-

cially tractor and power tiller during the peak season causes various large losses of revenue and inefficient utilization of labor. Examples of engine failure parts are as shown in Fig. 1. Therefore, it is necessary to routine check-up, inspect and diagnose of important parts of agricultural machinery for getting proper performance and timeliness operation. It is possible to adjust, repair and/or replace the defective component/parts according to diagnosed results. Non-destructive testing is a key inspection criterion across many fields of engineering. In agricultural machinery sector, reliable and accurate nondestructive testing of important parts of agricultural machineries and integrity assessment are both essential in order to maximize efficiency and minimize

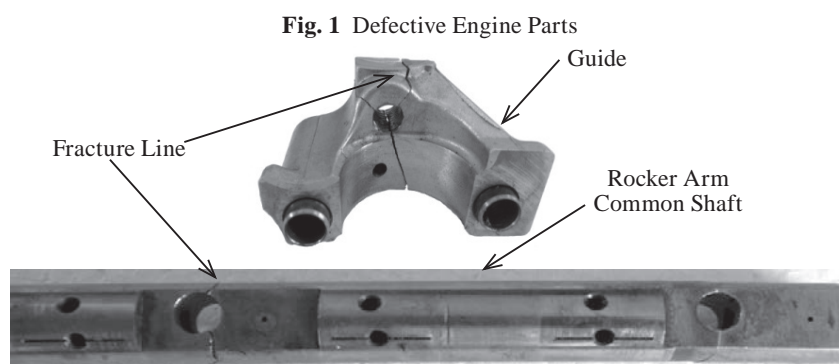


Fig. 1 Defective Engine Parts

downtime and improve productivity. There is no available technique/method to nondestructively evaluate/diagnose the important parts of agricultural machinery in Bangladesh. The four-point probe voltage drop technique can be considered one of the best solutions for the purpose. This technique is simple in construction and easy to handle for conducting experiment (Dover *et al.*, 1991). The Voltage Drop technique is popular for material evaluation because of its advantages over other techniques, including sensitivity, flexibility, and simplicity of application.

Several different techniques for electrical NDT have been developed; all of them share the same physical basis and can be described by Ohm's equations. Nevertheless, each technique has its own range of application, although most of them require the tested material to be a fairly good electrical conductor. In particular, a literature survey (Bowler *et al.*, 2005 and M. C. Lugg, 1989) showed that techniques such as Direct Current Voltage Drop and Alternating Current Voltage Drop, based on the injection of currents in the structure to be tested and on the measurement of the resulting voltage difference between two points on its surface which can help to identify some in-homogeneities that have been encountered in structure (Hwang *et al.*, 1992; Ditchburn *et al.*, 1996 and Ahmed *et al.*, 2006).

The main purpose of this study

was to develop a laboratory based nondestructive testing set up for evaluating internal defects/cracks in the important parts of agricultural machinery. Therefore, a DC four-point probe measuring system was designed, developed and evaluated to detect internal cracks and defects of machine parts nondestructively.

## Materials and Methods

### Design Consideration

From Ohm's law ( $V = IR$ ), if constant current provided to the sample by the current probes, the voltage will change with the change of resistance of the material. The voltage of a particular homogeneous metal will always be the same if there is no crack or defect. If there is any defect, the voltage will vary as it creates a resistance toward the path of flowing current. The generalized equations are as follows

$$\rho = (RA / L) \text{ and } \Delta\Phi = (2\rho I / \pi) \times [S_1 / (S_1^2 - S_2^2)] \dots \dots \dots (1)$$

(Ali *et al.*, 2010)

Where,

$\rho$  = Resistivity,  $\Omega\text{-m}$

R = Resistance,  $\Omega$

A = Area,  $\text{m}^2$

L = Length, m

I = Current, A

$\Delta\Phi$  = Voltage Drop, V

$\Pi$  = Constant

$S_1$  = Distance between center to current probe

$S_2$  = Distance between center to voltage probe

From Eqn. 1, resistivity of a material should be known to determine the defect in the material (Hwang *et al.*, 1992 and Dover *et al.*, 1980, 1986). The values of voltage drop measured at different location of the surface of the materials were used to determine the resistivity using Eqn. 1.

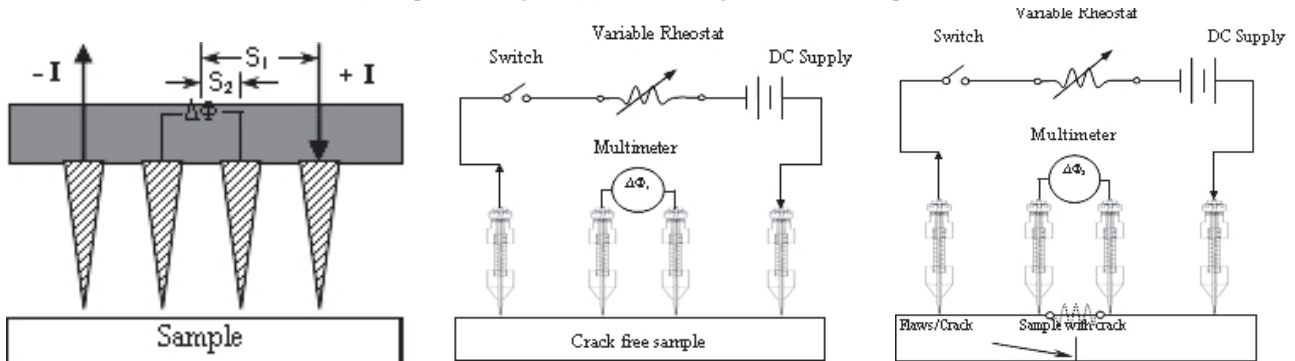
The probe used initially was based on the simplest configuration for Voltage Drop measurements (Hwang *et al.*, 1992) as shown in Figs. 2 (a) and (b) and consisting of two pairs of probes: one pair is used to inject current in the specimen to be tested, while the other measures accurate voltage drop. Finally, a calculator was made using C++ programming to calculate the voltage drop. A block diagram of the experimental setup is shown in Fig. 3.

### Selection of Sample and Type of Materials

The sample and materials were selected based on availability and cost of materials. The material used to make probes should be good conductor and plastic fibers were used as insulating materials to operate the whole setup safely.

A simple ammeter and precision multimeter were used to measure the current and voltage drop respectively. For precision and easy calculation, another calculator was made using Code::Blocks 12.11 with if-else nestle function in C++ programming language for calculation

Fig. 2 a) Simplified Diagram (b) Circuit Diagram of DC Four-point Probe



of resistivity using Eqn. 1.

### Design of Probe

A SS rod of 3.2 mm diameter was used as a probe. A compression spring was set between collar and tail (made of plastic fiber) to maintain rigid contact of probe with the surface of test material and to avoid sparking at the contact point between probe and sample. Direct current was used to get a good representation of current as alternating current changes its direction of flow according to sinusoidal curve. A 12V Battery was used as power

source. The construction, design of probes and arrangement are shown in Figs. 4 (a)-(h).

### Study Area and Investigation of Internal Crack

The study was conducted at the Electrical Engineering Lab, Department of Farm Power and Machinery, Bangladesh Agricultural University (BAU), Mymensingh. The tests were conducted on Mild Steel (MS) Bar, Stainless Steel (SS) Bar, Carbon Steel (CS) Bar to represent as the materials tine, crankshaft, PTO/propeller shaft, spline shaft etc. of

agricultural machines. For verifying the developed technique to detect the crack, artificial cracks were made in different depths by power saw or hacksaw as shown in Fig. 5 (a). The arrangement of four-probes on cracked sample is shown in Fig. 5 (b).

### Experimental Design for Mild Steel Flat Bar

Two pieces of MS flat bar of 180 mm × 25 mm × 4 mm were taken. Firstly the voltage drop was measured in crack-free specimen. One of them were cut by hacksaw and

Fig. 3 Block Diagram of DC Voltage Drop System

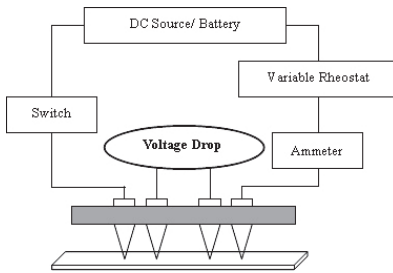
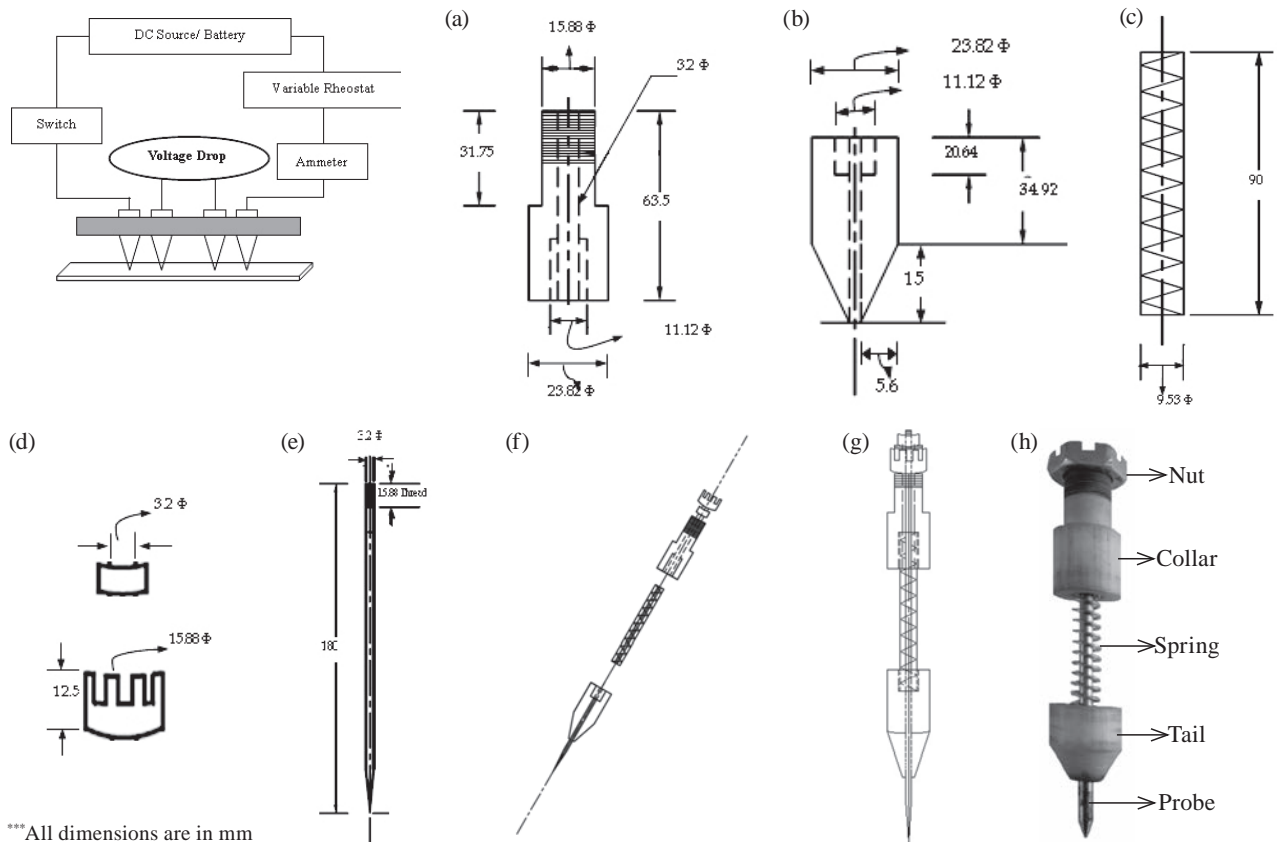
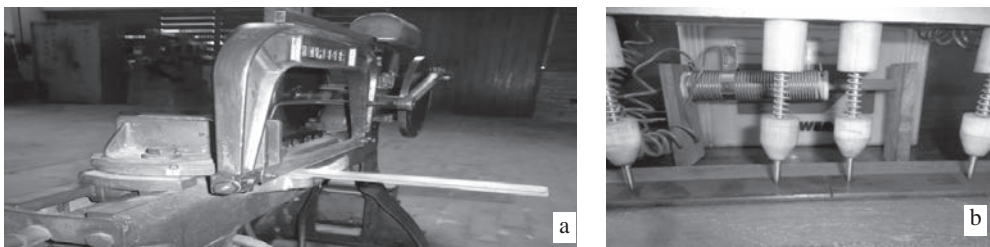


Fig. 4 (a) Collar (b) Tail (c) Spring (d) Nuts (e) Probe (f) Assembly Drawing of a complete probe (g) 2D View (h) Pictorial View of Probe



\*\*\*All dimensions are in mm

Fig. 5 (a) Artificial Crack by Power Saw (b) Arrangement of four probes on cracked sample



another one was twisted with the help of vice and hammer as shown in Fig. 6. After that the voltage drop was also measured on cracked sample and compared.

**Experimental Design for Stainless Steel Flat Bar**

A piece of SS flat bar of 180 mm × 25 mm × 6 mm was taken. At first voltage drop was measured in crack-free condition. Then it was cut by power saw at three different depths (1 mm, 2 mm and 3 mm) as shown in Fig. 7. Finally voltage drops were measured as for the MS flat bar.

**Experimental Design for Carbon Steel Flat Bar**

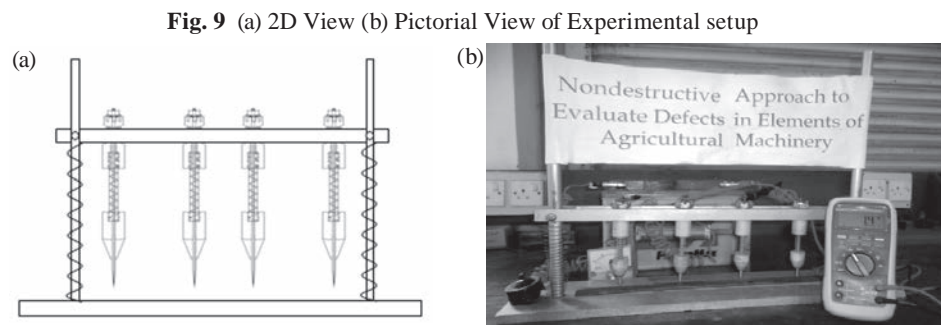
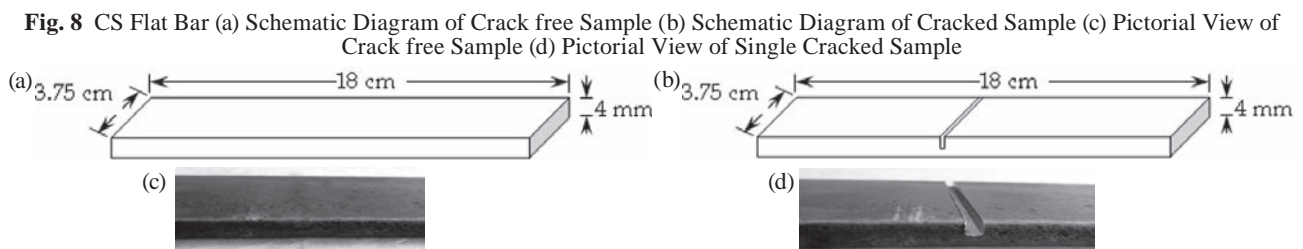
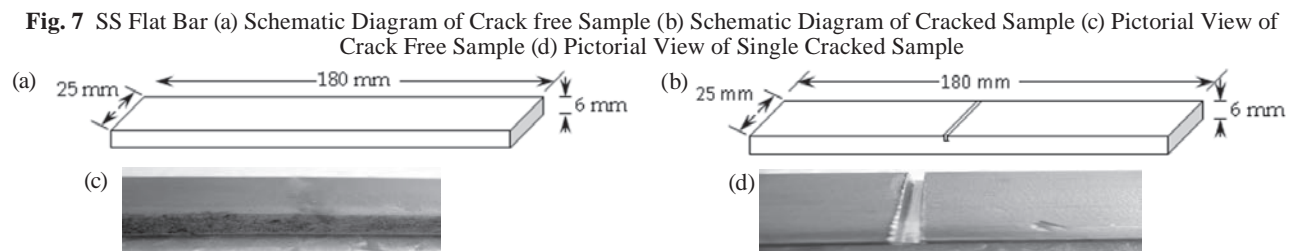
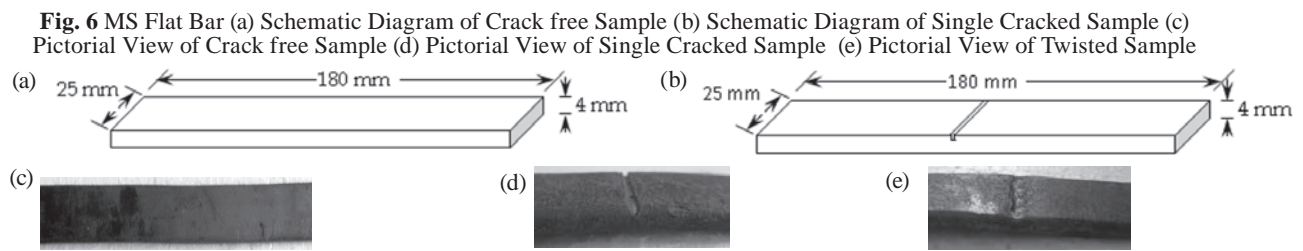
A piece of CS flat bar of 180 mm × 37.5 mm × 4 mm was taken for conducting experiment. First of all the voltage drop was measured in crack-free condition. Then it was cut by power saw in two different depths (1 mm and 2 mm) shown in Fig. 8.

**Test Sample Collection, Arrangement and Analysis**

Test sample with internal crack was collected from different agricultural machinery workshops. The

probes were set on the test samples rigidly. Data were analyzed according to the mathematical equations.

Five, Ten and Fifteen amperes of current were used on the specimens for a small period of time (5 to 10 sec) at four spacings: 152.50 and 50 mm, 177.50 and 50 mm, 152.50 and 25 mm, 125.00 and 25 mm. If the flow of current continues for a long time, heat will be generated on rheostat and there is a possibility to damage some parts of the set up. It has been shown that by simply repeating a measurement by multi-meter thus it was possible to further



**Table 1** Resistivity for MS Flat Bar in Crack free Condition

Current (A)	Spacing		Resistivity, $\rho$ ( $\Omega$ -m)	Sub-Average Resistivity, $\rho$ ( $\Omega$ -m)	Average Resistivity, $\rho$ ( $\Omega$ -m)
	$S_1$ (mm)	$S_2$ (mm)			
5	152.50	25	$1.70 \times 10^{-4}$	$1.5975 \times 10^{-4}$	$1.33 \times 10^{-4}$
	125.00	25	$1.31 \times 10^{-4}$		
	177.50	50	$1.82 \times 10^{-4}$		
	152.50	50	$1.56 \times 10^{-4}$		
10	152.50	25	$1.13 \times 10^{-4}$	$1.2325 \times 10^{-4}$	
	125.00	25	$1.03 \times 10^{-4}$		
	177.50	50	$1.54 \times 10^{-4}$		
	152.50	50	$1.23 \times 10^{-4}$		
15	152.50	25	$1.13 \times 10^{-4}$	$1.1725 \times 10^{-4}$	
	125.00	25	$1.13 \times 10^{-4}$		
	177.50	50	$1.39 \times 10^{-4}$		
	152.50	50	$1.04 \times 10^{-4}$		

improve the quality of the data.

## Results and Discussion

### Development of DC Four-Point Probe

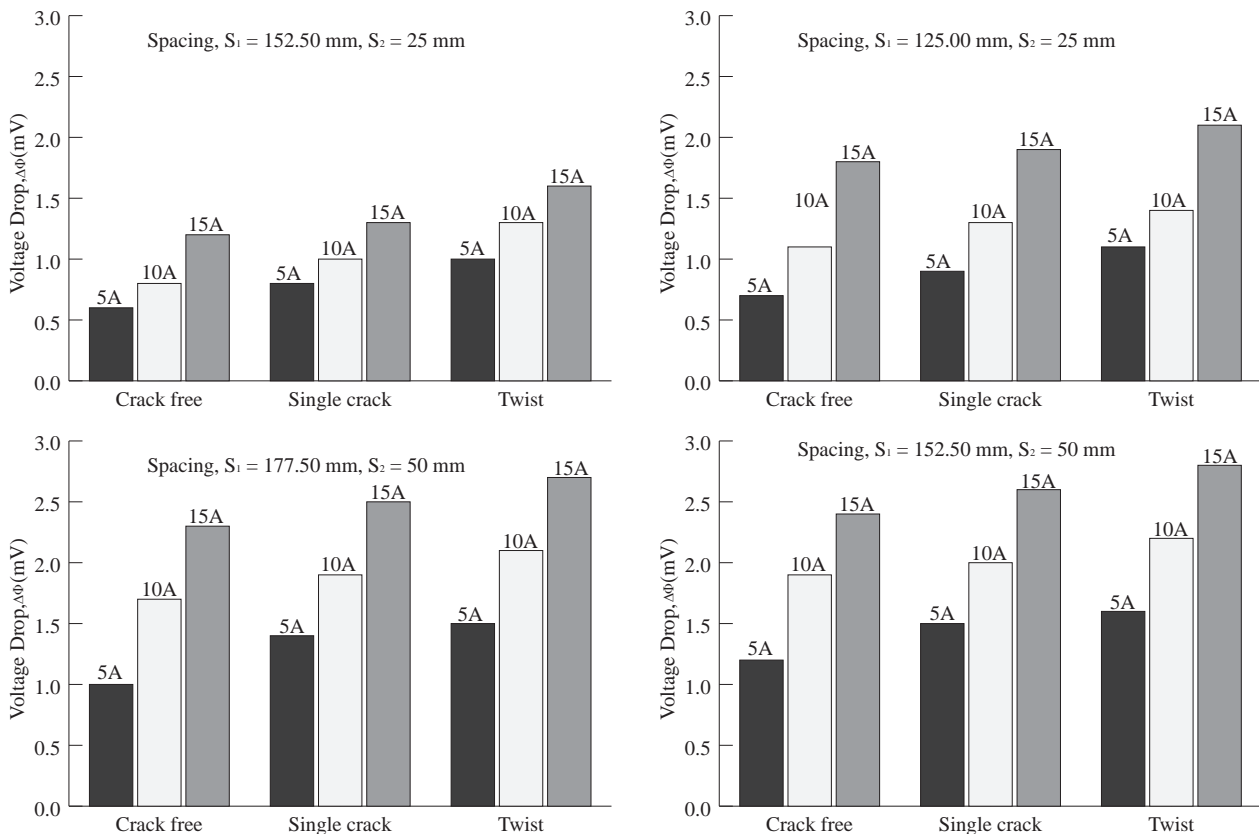
The probes were being set within a wooden frame to avoid spark-

ing and any conduction other than sample as shown in **Fig. 9a**. This frame was kept in a stand and here also compressive springs were used to set the arrangement rigidly on the experimental sample. The developed experimental set up is shown in **Fig. 9b**.

### Measurement of Voltage Drop

Measurements were taken on the experimental samples. The probes were positioned in the central area with no defect condition, then the single and double/ twisting cracks were done on the sample and the voltage drops were measured as shown in **Figs. 10-18**.

**Fig. 10** Comparison of Voltage Drop on different conditions of MS Flat Bar





### Voltage Drop on Mild Steel Flat Bar

Comparison of voltage drop and effect of probe spacing in case of different conditions of MS flat bar shown in **Figs. 10-12**.

The Resistivity for MS flat bar in different probe spacing and current in crack-free specimen is given in **Table 1**.

For same sample, different current and probe spacing were considered for determining the resistivity of the sample. The values of resistivity in **Table 1** are very close to one another. So the average value of  $\rho$  may be considered as resistivity of MS flat bar and **Fig. 12** shows resistivity with variation in different amount of currents.

**Figs. 10-11** indicate that the voltage drop increases with increasing of corresponding current. These Figures also show that the voltage drop of crack-free material is less than both of cracked and twisted sam-

ples. Crack increases resistance on the flow of current in material. So, both the resistance and voltage drop become higher in cracked specimen than crack-free. On the other hand, twisted material increases more resistance through the material due to several hair line cracks generated in the twisted part, therefore, it is higher than cracked one. The calculated value of voltage drop for the probe spacing 152.50 and 25 mm is less than that of 125.00 and 25mm. Similarly calculated value of voltage drop for 177.50 and 50 mm spacing is less than 152.50 and 50 mm spacing. **Fig. 12** shows, the calculated resistivity for MS flat bar in different amount of current are very close to one another.

### Voltage Drop on Stainless Steel Flat Bar

Comparison of voltage drop and effect of probe spacing in case of

different conditions of SS flat bar are also shown in **Fig. 13**.

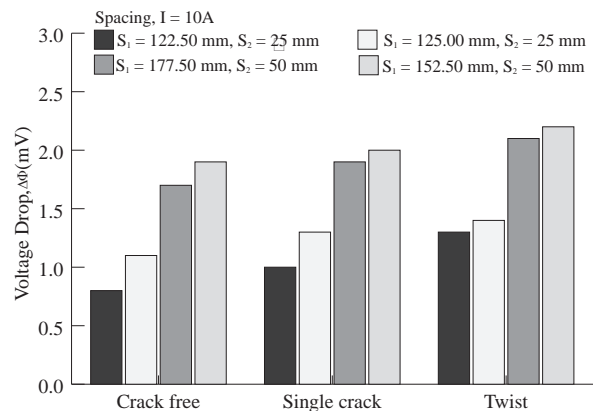
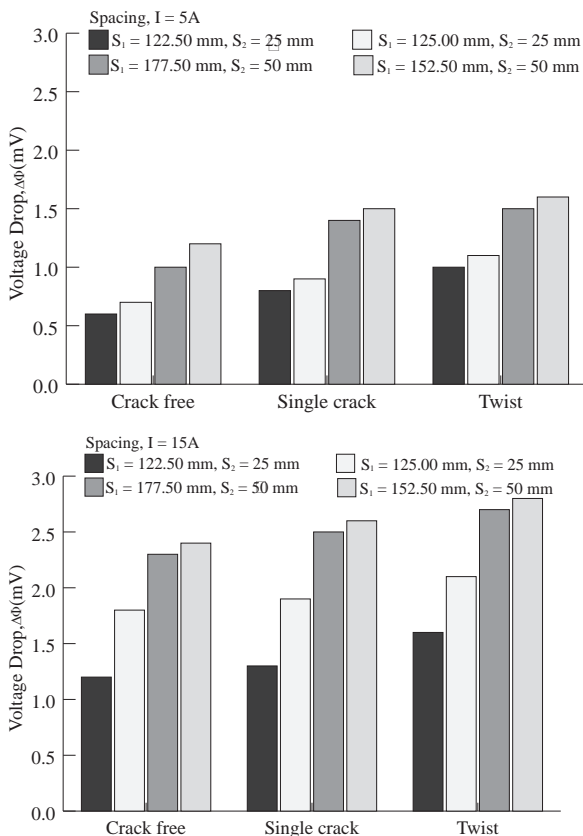
**Fig. 14** also indicates the similar result as mentioned in **Fig. 11** and the resistivity of different spacing and currents are shown in **Table 2** and finally represented in **Fig. 15**.

**Figs. 13-14** show 3 mm crack generated larger voltage drop than that of 1 mm and 2 mm crack as it creates more resistance toward the current flow path. The effect of spacing of probe is same as discussed for MS flat bar for different amount of current. The resistivity in different amount of current on SS flat bar in crack-free condition are very closer to one another as shown in **Fig. 15**.

### Voltage Drop on Carbon Steel Flat Bar

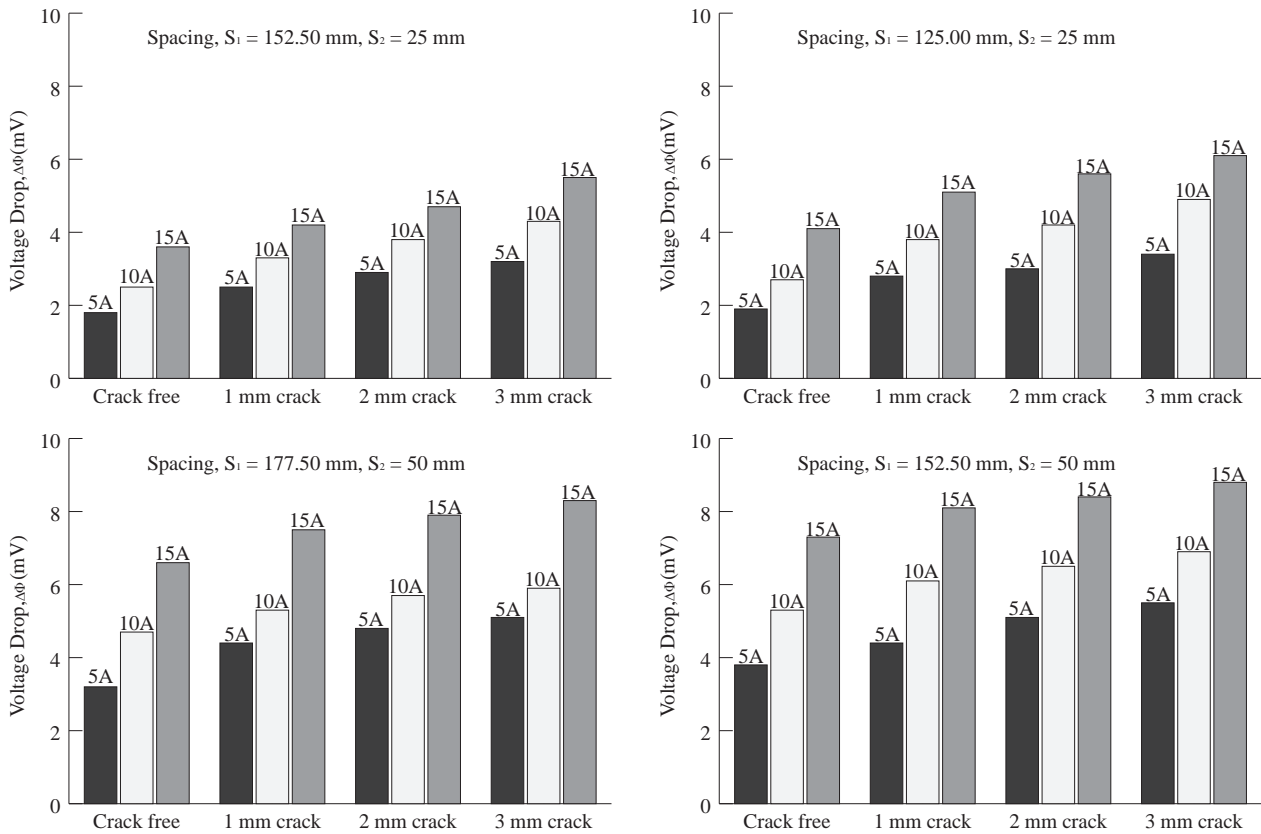
The same probe spacings were also being kept and measured re-

**Fig. 11** Effect of Probe Spacing on Voltage Drop for Different Conditions of MS Flat Bar

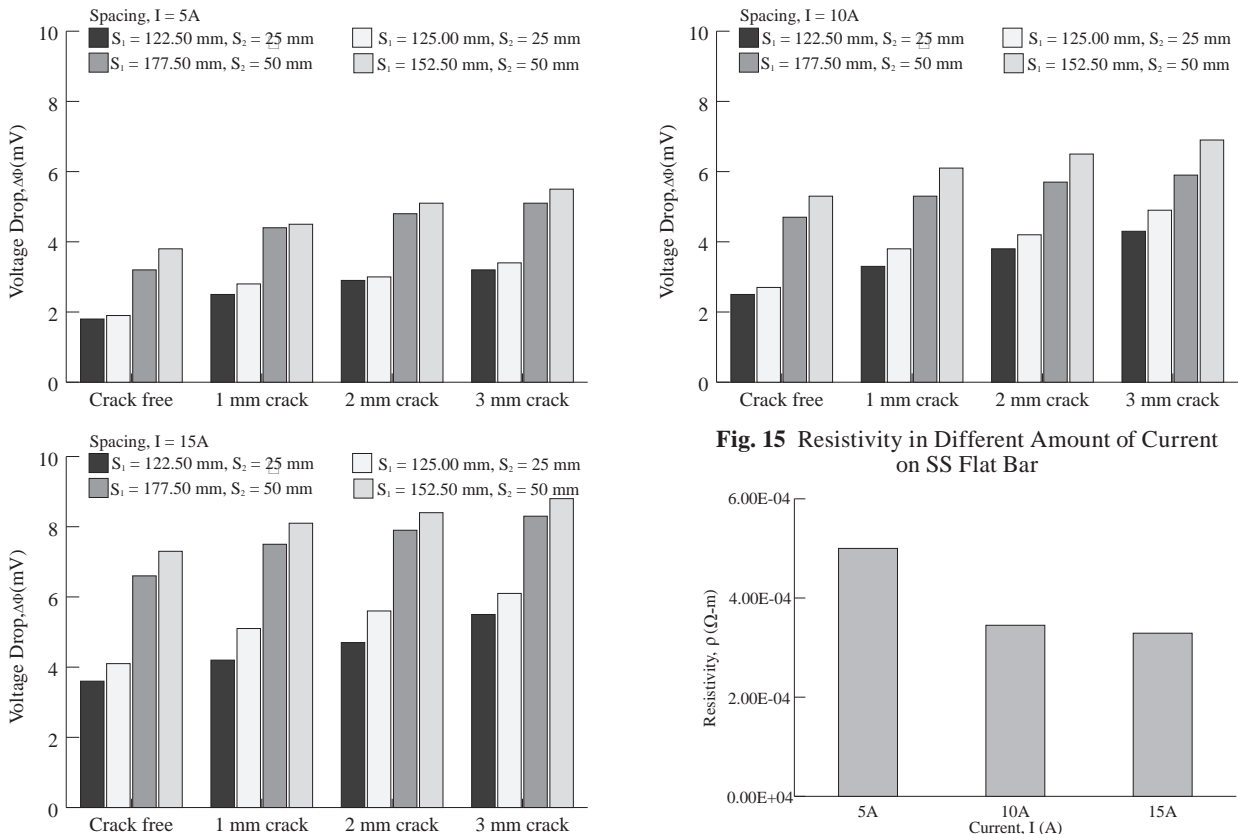


**Fig. 12** Resistivity in Different amount of Current on MS Flat Bar

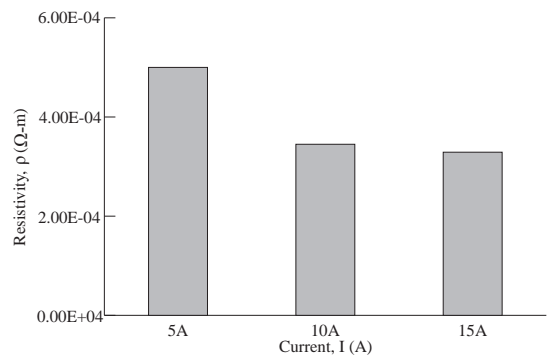
**Fig. 13** Comparison of Voltage Drop on Different Conditions of SS Flat Bar



**Fig. 14** Effect of Probe Spacing on Voltage Drop for Different Conditions of SS Flat Bar



**Fig. 15** Resistivity in Different Amount of Current on SS Flat Bar



**Table 2** Resistivity for SS Flat Bar in Crack free Condition

Current (A)	Spacing		Resistivity, $\rho$ ( $\Omega$ -m)	Sub-Average Resistivity, $\rho$ ( $\Omega$ -m)	Average Resistivity, $\rho$ ( $\Omega$ -m)
	$S_1$ (mm)	$S_2$ (mm)			
5	152.50	25	$5.11 \times 10^{-4}$	$5.0025 \times 10^{-4}$	$3.9150 \times 10^{-4}$
	125.00	25	$3.58 \times 10^{-4}$		
	177.50	50	$5.83 \times 10^{-4}$		
	152.50	50	$4.95 \times 10^{-4}$		
10	152.50	25	$3.55 \times 10^{-4}$		
	125.00	25	$2.54 \times 10^{-4}$		
	177.50	50	$4.28 \times 10^{-4}$		
	152.50	50	$3.45 \times 10^{-4}$		
15	152.50	25	$3.41 \times 10^{-4}$		
	125.00	25	$2.57 \times 10^{-4}$		
	177.50	50	$4.00 \times 10^{-4}$		
	152.50	50	$3.17 \times 10^{-4}$		

sults are shown in **Fig. 16**. It also provides similar results as described in previous section. The effect of probe spacings on voltage drop of CS flat bar are presented in **Fig. 17** and the resistivity of crack-free samples are given in **Table 3**.

The average value of resistivity for particular amount of current is

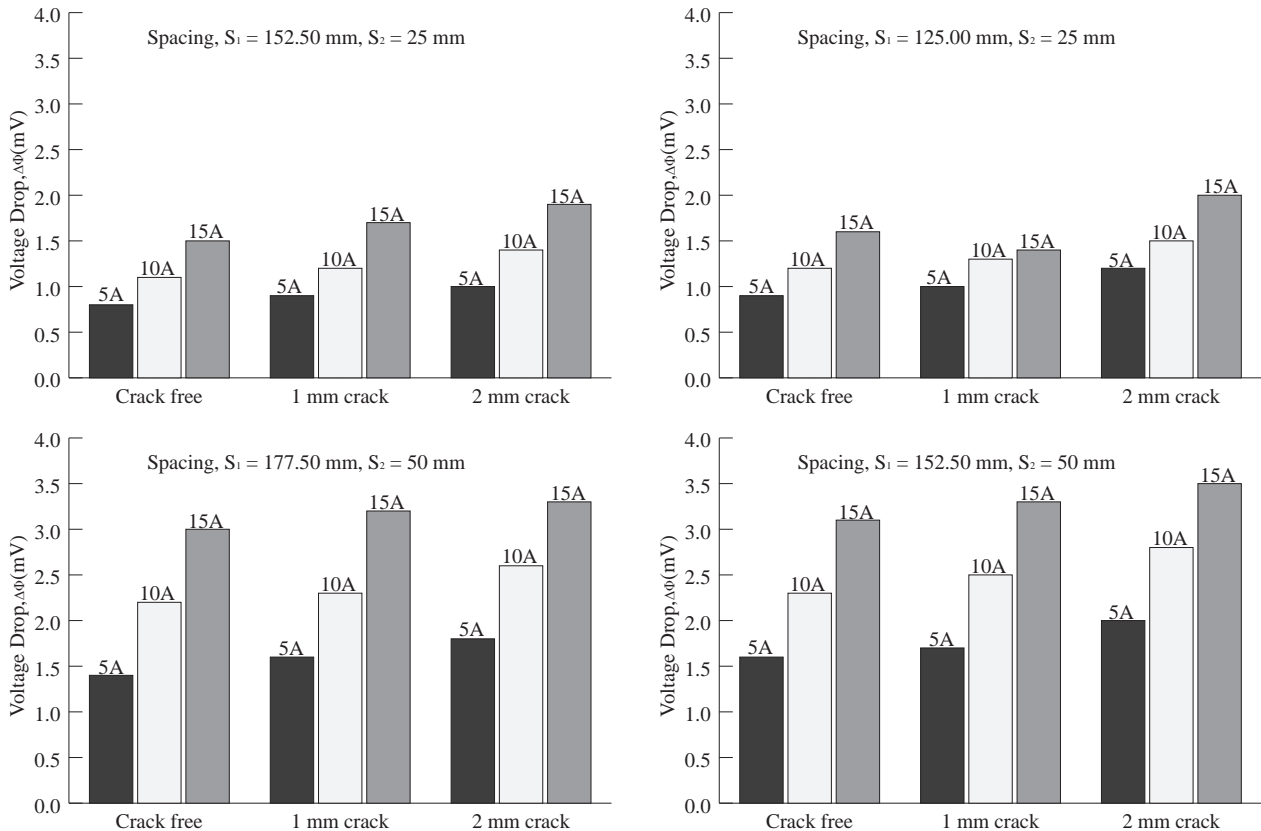
shown in **Table 3** and **Fig. 18**. The variation of resistivity from average value is also shown in **Fig. 18**. This variation is very small and it can be negligible.

The effects of voltage drop on different amount of current and spacing for CS flat bar are same as previously discussed for MS and SS

flat bar shown in **Figs. 16-17**. On the other hand, **Fig. 18** indicates the resistivity in different amount of current on CS flat bar.

**Figs. 10-18**, all experimental results show the same nature as calculated. The resistivity of the materials varies slightly for different conditions. Resistivity become slightly

**Fig. 16** Comparison of Voltage Drop on Different Conditions of CS flat bar



**Table 3** Resistivity Table for CS Flat Bar in Crack free Condition

Current (A)	Spacing		Resistivity, $\rho$ ( $\Omega$ -m)	Sub-Average Resistivity, $\rho$ ( $\Omega$ -m)	Average Resistivity, $\rho$ ( $\Omega$ -m)
	$S_1$ (mm)	$S_2$ (mm)			
5	152.50	25	$2.27 \times 10^{-4}$	$2.1475 \times 10^{-4}$	$1.7375 \times 10^{-4}$
	125.00	25	$1.69 \times 10^{-4}$		
	177.50	50	$2.55 \times 10^{-4}$		
	152.50	50	$2.08 \times 10^{-4}$		
10	152.50	25	$1.56 \times 10^{-4}$	$1.5450 \times 10^{-4}$	
	125.00	25	$1.13 \times 10^{-4}$		
	177.50	50	$2.00 \times 10^{-4}$		
	152.50	50	$1.49 \times 10^{-4}$		
15	152.50	25	$1.42 \times 10^{-4}$	$1.5200 \times 10^{-4}$	
	125.00	25	$1.50 \times 10^{-4}$		
	177.50	50	$1.82 \times 10^{-4}$		
	152.50	50	$1.34 \times 10^{-4}$		

larger when small amount of current is being flown into the material. The resistivity depends on the material composition and properties.

The test results indicate that size of even the simplest defects may not be straight forward and that a few issues need to be addressed before trying to evaluate defects. In

particular, if the length of a defect is finite, currents can flow not only below the defect, but also around its extremities. In case of single crack the voltage drop is smaller than twisted one.

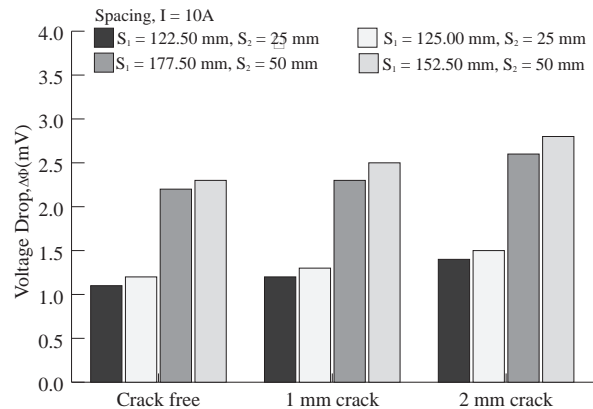
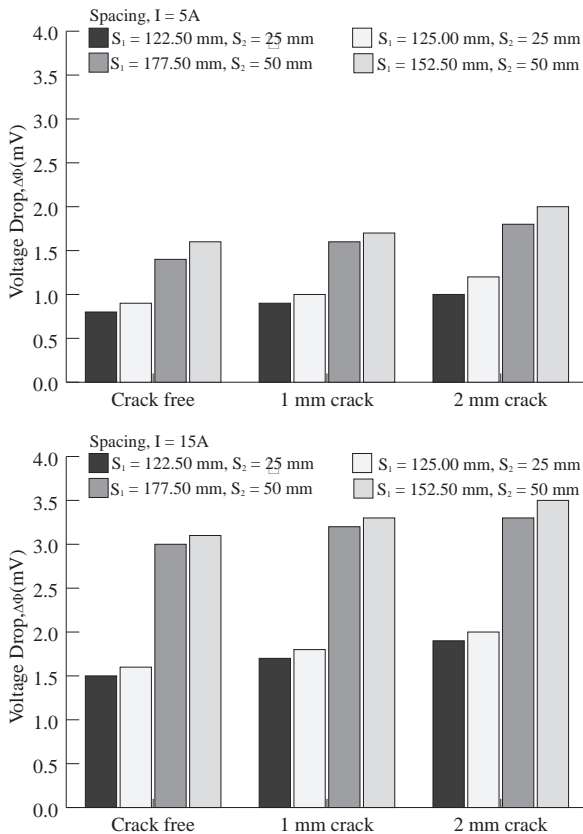
Four-point probe technique was developed for acquisition of Voltage Drop data. The results of experi-

mental measurements of resistivity are very close to one another for different conditions. It indicates that the developed technique is suitable for such kind of experiment.

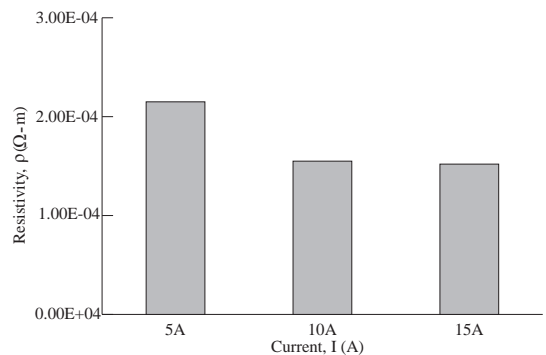
**Computer Based Calculation Process**

For precision results, Two cal-

**Fig. 17** Effect of Probe Spacing for Different Conditions of CS Flat Bar



**Fig. 18** Resistivity in Different Amount of Current on CS Flat Bar



calculation procedures were developed based on the **Eqn. 1** using code::blocks 12.11 (C++ programming language): One for voltage drop calculation and another one for resistivity measurement. The GUIs (Graphical User Interface) are shown in **Figs. 19a** and **b**.

## Conclusions

A low-current experimental setup for Voltage Drop measurements was developed to determine cracks in the machine parts. Variation of voltage drop on the same sample before and after cracks indicates the presence of defects of the material by a simple, non-iterative formula. The developed technique is capable to detect any inhomogeneity (defects) and to determine resistivity. Finally, a simple computer based calculator was made to find out the resistivity and voltage drop according to the formula.

## Acknowledgements

The financial assistant provided by Ministry of Education, The People's Republic of Bangladesh (Project No. 2013/155/MoE) is gratefully acknowledged. The Department of Farm Power and Machinery, Bangladesh Agricultural University, Mymensingh is also acknowledged for providing opportunity to carry out this project.

## REFERENCES

Ahmed, S. R. and M. Saka. 2006.

Nondestructive Measurement of the Respose of Rear-Wall Flaws in Thick-Walled Structures Using DC Four-Point-Probes Technique. Asia-Pacific Conference on NDT.

Ali, M. R., M. Saka, and H. Tohmyoh. 2010. Checking Surface Contamination and Determination of Electrical Resistivity of Oxide Scale Deposited on Low Carbon Steel by DC Potential Drop Method. The Japanese Society for Non-Destructive Inspection: Materials Transactions, 51(8): 1414-1419.

Bowler, N. and Y. Huang. 2005. Model-Based Characterization of Homogeneous Metal Plates by Four-Point Alternating Current Potential Drop Measurements. IEEE Transactions on Magnetics, 41(6): 2102-2110.

Ditchburn, R. J., S. K. Burke, and C. M. Scala. 1996. NDT of Welds: State of the Art. NDT&E International, 29(2): 111-117.

Dover, W. D., F. D. W. Charlesworth, K. A. Taylor, R. Collins, and D. H. Michael. 1980. AC Field Measurement Theory and Practice. In C. J. Beevers, editor, The Measurement of Crack Length and Shape During Fracture and Fatigue, pages 222-260. Engineering Materials Advisory Service, Warley, UK.

Dover, W. D., R. Collins, and D. H. Michael. 1986. The Use of AC-Field Measurements for Crack Detection and Sizing in Air and Underwater. Philosophical Transactions of the Royal Society of London A: Mathematical Physical and Engineering Sciences, 320:271-283.

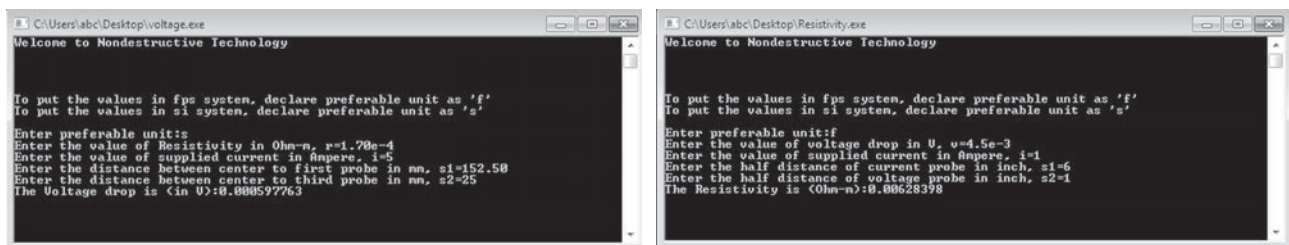
Dover, W. D., R. Collins, and D. H. Michael. 1991. Review of Developments in ACPD and ACFM. British Journal of NDT, 33(3):121-127.

Hwang, I. S. and R. G. Ballinger. 1992. A Multi-Frequency AC Potential Drop Technique for the Detection of Small Cracks. Measurement Science and Technology, 3: 62-74.

Lugg, M. C. 1989. Data Interpretation in ACPD Crack Inspection. NDT International, 22(3): 149-154.

■ ■

**Fig. 19** GUI for calculation (a) Voltage Drop (b) Resistivity





# Parametric Standardization of Catalyst Removal from Transesterified Palm Oil Through Wash Water

by

S. K. Chaudhary

Department of Farm Power & Renewable Energy,  
College of Agricultural Engineering,  
Rajendra Agricultural University,  
Pusa- 848 125 Bihar, INDIA  
skchoudhary37049@gmail.com



T. K. Bhattacharya

Dean,  
College of Agricultural Engineering,  
Jawaharlal Nehru Krishi Vishwa Vidyalaya,  
Jabalpur 482 004 M.P.  
INDIA



V. B. Shambhu

Sr. Scientist,  
National Institute of Research on Jute  
& Allied Fibres 12, Regent Park,  
Kolkata -700 040  
West Bengal, INDIA  
vbs9605@gmail.com

## Abstract

The study related to the removal of catalyst from transesterified palm oil through wash water was carried out with wash water temperature of 50 °C and normal water, which was at around  $28 \pm 2$  °C temperature. Standardized parametric conditions for maximum catalyst removal were determined through full factorial statistical design of the experiment. The parameters like wash water to biodiesel ratio, retention period of wash water with biodiesel and wash water temperature was found to be significantly affected the removal of catalyst. It was further observed that maximum amount of catalyst (0.631 g/L of solution) was removed, when water to biodiesel ratio was kept at 3:1, retention period of wash water with biodiesel as 30 min and wash water temperature as  $28 \pm 2$  °C.

## Introduction

Worldwide energy crisis, reduc-

ing fossil fuel reserves and concern about environment act as a driving force behind the search of alternative fuel. In India, the country's diesel requirements in 2011-12 could be more than 66 million tones, one and a half times higher than in 2001-02. The Energy and Resource Institute (TERI) estimated that India's diesel need would cross 100 million tones by 2020 and 200 million tones by 2030. Vehicular population of India is estimated to have increased eight times over the last two decades. This source alone is estimated to contribute about 70 % to the total air pollution, With 243.3 MT of carbon released from the consumption and combustion of fossil fuels in 1999, India ranked fifth in the world behind the U.S., China, Russia and Japan. India's contribution to world carbon emissions is expected to increase in the coming years due to the rapid urbanization.

In India with abundance of forest resources, there are number of non-edible tree borne oil seeds with an estimated annual production of

more than 20 million tones, which have great potential for making biodiesel to supplement other conventional sources. Among these, Karanja (*Pongamia glabra*) and Jatropha (*Jatropha curcas*) have been successfully proved for their potential as biodiesel. Mahua (*Madhuca indica*) is one such non edible tree based seed oil, which has an estimated annual production potential of 181 thousand metric tonnes in India (Kaul *et al.*, 2003).

Biodiesel is produced through a chemical reaction known as transesterification. Transesterification is defined as the chemical process of reacting vegetable oil, a triglyceride, with an alcohol in the presence of a catalyst to produce glycerol and fatty acid ester. Most of the work throughout the world on the transesterification of vegetable oil has been carried out with the methanol, which is toxic, poisonous in nature and obtained from the nonrenewable source of energy. It has several advantages compared to other alcohols like being not expansive,

prevents soap formation, reactivity is high and also methanol recovery comparatively is easier, as it does not form azeotrope. Most biodiesel production processes use excess methanol to get high yield. This excess methanol is distributed between final product alkyl ester (Biodiesel) and glycerol. Conventional biodiesel production technology uses wash water to remove excess amount of methanol and catalyst from the final product biodiesel. As the washing of glycerol and alkaline catalyst from ester, water is to be added and for the large scale production of biodiesel, discharge of this large quantity of washed water will create a problem. Present study was therefore conducted to establish an optimized parametric conditions at which maximum amount of catalyst was removed from the biodiesel.

## Materials and Methods

The materials used in the experiment were procured from local market. The experiments were carried out in the Bioenergy Technology Laboratory of the Department of Farm Machinery and Power Engineering, Govind Ballabh Pant University of Agriculture & Technology (Pantnagar), India.

### Catalyst Removal from Biodiesel

The transesterification of palm oil for biodiesel production was carried out using KOH as catalyst having 1 % concentration. In this experiment, biodiesel prepared was placed in a separating funnel for 24h for separation of glycerol and biodiesel. Since, removal of catalyst from biodiesel requires that it be washed using water, therefore, after separating glycerol, the ester (biodiesel) was washed with water. The washing of biodiesel not only reduces the catalyst concentration but also removes methanol and traces of soap, if any present in the biodiesel. The **Table 1** shows the variables selected

for removal of catalyst from biodiesel. The washing of biodiesel using wash water at 50 °C was suggested by Karoasmanoglu *et al.* (1996) to obtain high purity of biodiesel and therefore, this wash water temperature level was selected. Also wash water temperature of 28 ± 2 °C was selected as this is being the normal temperature of tap water. Agarwal *et al.* (2001) suggested water to oil ratio of 8 : 1 for removal of catalyst and other impurities, whereas Benargee *et al.* (2005) has suggested it to be 5 : 1. Taking these two studies into consideration, water to oil ratio of 3 : 1 was also considered for the experiment to establish the optimum level. The removal of catalyst from biodiesel is also affected by the period, to which water and oil remain in contact, and Benargee *et al.* (2005) suggested a period of 45 min. and therefore the retention period of 15, 30 and 45 min. were selected for the study.

### Design of Experiments:

A full factorial statistical design having three factors viz. wash water to oil ratio, retention period and wash water temperature with three levels of first two factors and two levels of third factor were considered for this study. A total 54 number of experiments were carried out to determine the removal of residual catalyst from biodiesel. The results of the experiments were statistically analyzed to know the significance of each parameter as well as their interaction.

### Determination of Catalyst Concentration in Wash Water

Catalyst concentration in the wash water (tap water) was determined by titration method. For the determination of residual catalyst concentra-

tion in washed water, 100 ml of wash water sample was titrated at each design run against 0.1 N HCL using methyl orange as an indicator. Methyl orange gives a sharp colour change from straw yellow to pink at the end point. The amount of catalyst removal from biodiesel was calculated using **Eqns. 1 and 2.**

$$\text{Normality of washed water} = (\text{Normality of HCL} \times \text{Volume of HCL}) / \text{ml of sample taken for estimation} \dots (1)$$

$$\text{Catalyst Removed (g/L)} = \text{Normality of wash water} \times \text{Equivalent weight of catalyst (g/L)} \dots (2)$$

## Results and Discussion

The water/oil ratio, retention period and temperature of wash water were taken as independent variables to study catalyst removal from biodiesel and a factorial design was adopted for the experiment.

### Determination of Catalyst Concentration in Washed Water

The Transesterification of palm oil was carried out using KOH as catalyst having 1 % concentration. After transesterification, some amount of catalyst remains in biodiesel. The biodiesel is, therefore, required to be washed to remove catalyst to maximum possible extent as presence of catalyst may cause damage to engine parts. Further, disposal of biodiesel wash water containing catalyst also poses environmental concern. In view of above, to assess removal of catalyst from biodiesel was conducted.

The observation on catalyst concentration in wash water after the biodiesel was washed with different water to biodiesel ratio is shown in **Table 2.** It is evident from these re-

**Table 1** Variables and their levels selected for washing of Biodiesel

Parameters	Levels		
Wash Water - Oil Ratio	3 : 1	5 : 1	8 : 1
Retention Periods of oil in wash water, min.	15	30	45
Water Temperature of wash water, °C	28 ± 2		50

sults that average KOH concentration in wash water was 0.441, 0.427, 0.419 g/L and 0.631, 0.566, 0.477 g/L and 0.544, 0.494, 0.593 g/L when biodiesel was washed using wash water having temperature of  $28 \pm 2$  °C and retention time of 15, 30 and 45 min at water to biodiesel ratio 3 : 1, 5 : 1 and 8 : 1 respectively.

The washing of biodiesel using wash water having 50 °C temperature resulted in catalyst concentration of 0.439, 0.409, 0.419 g/L and 0.486, 0.458, 0.484 g/L and 0.546, 0.511, 0.431 g/L in wash water for retention time of 15, 30 and 45 min at water to biodiesel ratio of 3 : 1, 5 : 1 and 8 : 1 respectively.

The relationship between water to biodiesel ratio and catalyst concentration in wash water at different retention period of biodiesel with wash water using wash water having  $28 \pm 2$  °C and 50 °C temperatures are shown in **Fig. 1** and **Fig. 2**. It is evident from the Figures that the more removal of catalyst from biodiesel has occurred when biodiesel was washed using water to biodiesel ratio of 3 : 1 as compared to other selected ratios as the catalyst concentration in wash water was observed higher. This can be attributed to the fact that for the condition of uniform agitation of 10 min in all the three cases, a better mixing of biodiesel with water has occurred at 3 : 1 ratio due to less amount of water present in the mixture.

The Figures also reveal that concentration of catalyst in wash water

**Table 2** Catalyst Concentration in Wash Water

Water : Biodiesel Ratio	Average Catalyst Concentration in Wash water, g/L					
	Retention Time of Wash water, min					
	15 min		30 min		45 min	
	Wash Water Temperature, °C					
	$28 \pm 2$	50	$28 \pm 2$	50	$28 \pm 2$	50
3 : 1 (W <sub>1</sub> )	0.441	0.439	0.631	0.486	0.544	0.546
5 : 1 (W <sub>2</sub> )	0.427	0.409	0.566	0.458	0.494	0.511
8 : 1 (W <sub>3</sub> )	0.419	0.419	0.447	0.484	0.593	0.431

was found more when the biodiesel was retained in wash water for 30 min compared to 15 or 45 min retention time. Normally, at the initial level due to agitation, the kinetic energy causes dissociation of hydroxyl ion in a catalyst, which increases solubility of a solute (catalyst) in a solution. But after certain period the hydroxyl ion unites and reduces solubility. Hence, lesser catalyst concentration at 45 min retention time might be due to above phenomenon. The observation on effect of wash water temperature on catalyst concentration does not indicate any appreciable difference in catalyst removal from biodiesel as catalyst concentration in wash water for all observations are very close to each other except for 30 min retention time. Whereas, for 3 : 1 and 5 : 1 water to biodiesel ratio the difference is 23 and 19 % respectively for wash water temperature of  $28 \pm 2$  and 50 °C. Thus based on above observation it can be said that washing of biodiesel with wash water temperature of  $28 \pm 2$  °C may save energy as no heating of water is re-

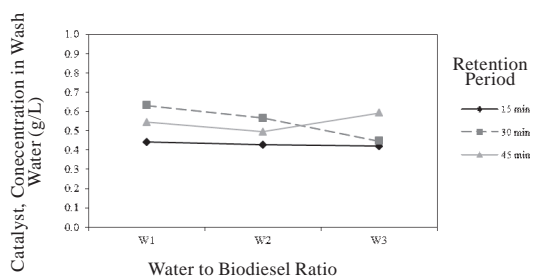
quired.

The statistical analysis to assess effect of selected parameters on catalyst concentration in wash water is presented in **Table 2**. It is evident from the data that all the three selected parameters viz. water to biodiesel ratio, retention time of biodiesel in wash water and wash water temperature has significant effect on removal of catalyst from biodiesel. The study therefore, indicate that higher removal of catalyst from biodiesel is possible, if it is washed by water to biodiesel ratio of 3 : 1 using wash water at  $28 \pm 2$  °C temperature and if biodiesel is retained with wash water for 30 min duration.

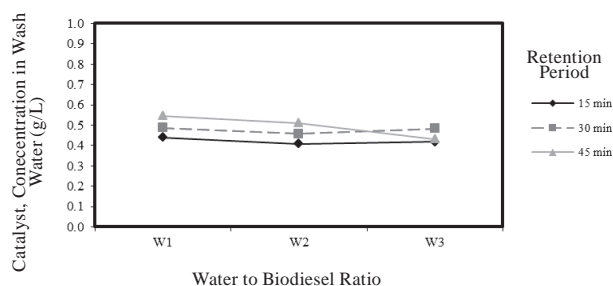
## Conclusions

The present study indicated that higher removal of catalyst from biodiesel was obtained when biodiesel was washed with water to biodiesel ratio of 3 : 1 at retention period of wash water for 30 min and wash water temperature at  $28 \pm 2$  °C. The

**Fig. 1** Effect of water to biodiesel ratio on catalyst concentration in wash water at different retention period and wash water temperature of  $28 \pm 2$  °C



**Fig. 2** Effect of water to biodiesel ratio on catalyst concentration in wash water at different retention period and wash water temperature of 50 °C



removal of catalyst at the rate of 0.63 g/L was observed at above condition.

#### Acknowledgements

Authors are very much thankful to the Indian Council of Agricultural Research for providing financial assistance under renewable energy scheme for pursuing research work at Bioenergy Laboratory of Department of farm Machinery and Power Engineering, College of Technology, Govind Ballabh Pant University of Agriculture & Technology (Pantnagar), India.

#### REFERENCES

- Agarwal, A. K. and L. M. Das. 2001. Biodiesel development and characterization for use as a fuel in compression ignition engines. *Journal of Engineering for Gas Turbines and Power*, 123: 440-447.
- Banerjee, T., T. K. Bhattacharya, and R. K. Gupta. 2005. Process Optimization of Catalyst Removal and Characterization of Waste Water after Alkali-Catalyzed Transesterification of Jatropha Oil. *IJGE* 090411.
- Choudhary, S. K. and T. K. Bhattacharya. 2011. Development of a Predictive Model for Parametric Standardization of Methanol Recovery from Transesterified Oil and Fuel Characterization of Biodiesel, Ph. D Thesis, G. B. Pant University of Agriculture and Technology, Pantnagar.
- Ghadge, S. V. and Hifjur, Rehman. 2006. Process optimization for biodiesel production from mahua (*Madhuca indica*) oil using response surface methodology. *Bioresource Technology*, 97(3): 379-384.
- Karaosmanoglu, F., K. B. Cigizoglu, M. Tuter, and S. Ertekin. 1996. Investigation of the refining step of biodiesel production. *Energy Fuels*, 10: 890-895.
- Kaul S, A. Kumar, A. K. Bhatnagarm, H. B. Goyal, and A. K. Gupta. 2003. Biodiesel: a clean and sustainable fuel for further scientific strategies for production of non-edible vegetable oils for use as biofuel. In All India Seminar on National Policy on Non-edible Oils as Biofuel, SUTRA, IISc, Bangalore.

■ ■

---

## ABSTRACTS

The ABSTRACTS pages is to introduce the abstracts of the article which cannot be published in whole contents owing to the limited publication space and so many contributions to AMA. The readers who wish to know the contents of the article more in detail are kindly requested to contact the authors.

1508

**Fuel Characterization of Palm Oil Methyl Esters and Their Suitability as CI Engine Fuel:** S. K. Chaudhary, STA, College of Agricultural Engineering, Rajendra Agricultural University, Pusa- 848 125 Bihar, INDIA. T. K. Bhattacharya, Dean, College of Agricultural Engineering, Jawaharlal Nehru Krishi Vishwa Vidyalaya, Jabalpur 482 004 M.P., same; V. B. Shambhu, Senior Scientist, National Institute of Research on Jute & Allied Fibres, Kolkata -700 040, West Bengal, same. vbs9605@gmail.com

Study on Fuel Characteristics of diesel, washed biodiesel, biodiesel containing methanol and biodiesel from which methanol has been recovered were carried out to asses their compatibility with petro diesel. Biodiesel was prepared using palm oil of 0.81% FFA. Performance of a 3.73 kW CI engine was assessed on diesel as well as on different types of selected palm methyl esters. It was found that both treated and untreated biodiesel when used as engine fuel developed similar power as that by diesel. The fuel consumption of the engine was slightly higher on untreated biodiesel due to presence of 8.1 to 11.6 % methanol in it. The brake thermal efficiency of the engine was lower on untreated biodiesel in comparison to treated biodiesel but higher than that of diesel.

■ ■

# Kitchen Bio-Wastes Management by Vermicomposting Technology



by  
Said Elshahat Abdallah  
Associate Professor  
saidelshahat@agr.kfs.edu.eg



Wael Mohamed Elmessery  
Lecturer

Department of Agricultural Engineering, Faculty of Agriculture, Kafrelsheikh University, Kafr Elsheikh 33516, EGYPT

## Abstract

Rapid urbanization has led to dumping of kitchen wastes causing a serious threat to the environment. A kitchen waste is undertaken in this study due to its majority in municipal wastes and the disposal process of it is costly. Two types of vermireactors (with and without trays) at three different areal loadings running under three different evaporative cooling vermicomposters (passive, direct active and indirect active) were operated for seven weeks experimentation period. The substrate moisture content and its temperature were monitored regularly and the vermireactors were evaluated weekly for the assessment of temporal changes of earthworms. Transformation of kitchen wastes into valuable added product, through vermicomposting process, by using Earthworms (*Eisenia foetida*) that were introduced at the initial stocking density of  $26.45 \pm 1.77 \text{ mg/cm}^3$  ( $1.85 \pm 0.12 \text{ kg/m}^2$ ). The experiment revealed that direct evaporative cooling vermicomposter reaches the optimum ambient condition; relative humidity of 70-80 % and air temperatures of 20-27 °C. So both vermireactors have the highest vermicast production of 0.28-0.36 g-cast/g-worm/day, but the vermireactor with trays and areal loading of

743.7 cm<sup>2</sup>/kg of feed was dramatically higher than the output in the corresponding vermireactors without trays. Vermicomposting results had significant differences between all treatments ( $P < 0.05$ ).

**Keywords:** vermicomposting process, earthworms, kitchen wastes, vermireactor.

## Introduction

Vermicomposting is the result of combined activity by microorganisms and earthworms (Singh *et al.*, 2011) and does not involve a thermophilic stage (Dominguez, 2004) in contrast to composting. Composting and vermicomposting are ecologically and economi-

cally sustainable technologies and have been widely used (Sinha *et al.*, 2010). Composting involves the accelerated degradation of organic matter by microorganisms under controlled conditions, in which the organic material undergoes a characteristic thermophilic stage that allows sanitization of the waste by the elimination of pathogenic microorganisms (Lung *et al.*, 2001). However, composting requires long duration and frequent turning of the material which results in loss of nutrients during the prolonged process (Eghball *et al.*, 1997). The high temperatures (> 60 °C) associated with the process are also known to inhibit decomposition (Bardos and Lopez-Real, 1991). Vermicomposting involves bio-oxidation and

### Nomenclature

PEVR	Passive evaporative cooling vermicomposter
DEVVR	Direct active evaporative cooling vermicomposter
IEVR	Indirect active evaporative cooling vermicomposter
PEVRT	Passive evaporative cooling vermireactors with trays
PEVRWT	Passive evaporative cooling vermireactors without trays
DEVVRT	Direct active evaporative cooling vermireactors with trays
DEVVRWT	Direct active evaporative cooling vermireactors without trays
IEVRT	indirect active evaporative cooling vermireactors with trays
IEVRWT	indirect active evaporative cooling vermireactors without trays
T	With trays
WT	Without trays
Tr	Tray
Re	Vermireactor



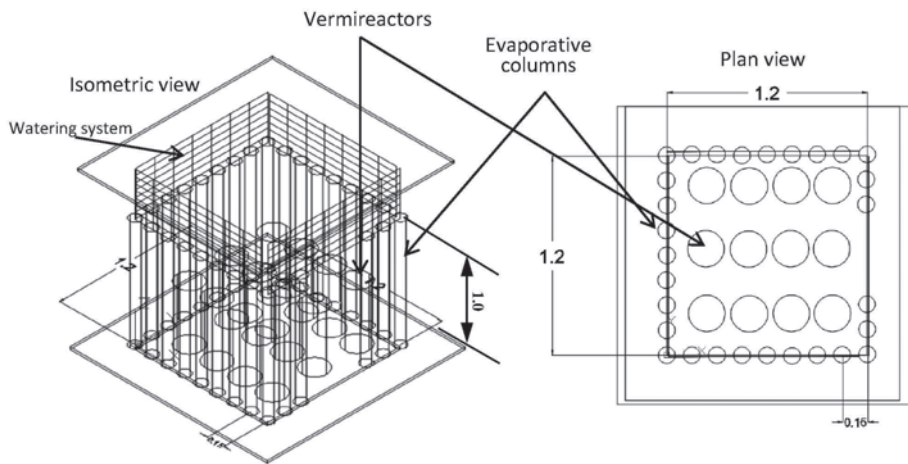
stabilization of organic material by the joint action of earthworms and mesophilic microorganisms under aerobic conditions. During vermicomposting, earthworms turn, ingest, grind and digest organic waste with the help of microflora in their gut, converting it into a much finer, humidified microbiologically active material (Maboeta and van Rensburg, 2003). However, pathogen removal is not ensured since the temperature is always in the mesophilic range, although some studies have provided evidence of suppression of pathogens (Eastman *et al.*, 2001; Monroy *et al.*, 2008; Yadav *et al.*, 2010). Earthworms modify microbial biomass and activity through stimulation, digestion and dispersion in casts, thereby affecting microbial decomposition process (Aira *et al.*, 2007; Gomez-Brandon *et al.*, 2011). The vermicast obtained at the end of the process is rich in plant nutrients and is free of pathogenic organisms (Singh *et al.*, 2011). Several earthworm species are suitable for the kitchen wastes treatment, with *Eisenia andrei* and *Eisenia foetida* being the most commonly used (Khwaitrakpam and Bhargava, 2009). The action of earthworms breaking down the substrate accelerates the rate of decomposition. Vermicomposting on the home scale could be an alternative when space restrictions are a concern. Vermicomposting involves the stabilization of organic solid wastes through consumption by earthworms that convert the waste into earthworm castings (vermicasts). There is a growing interest in vermicomposting research, i.e. testing new wastes, new earthworm species, and evaluation of vermicompost in recent past (Yadav and Garg, 2011). The products of vermicomposting are of high agronomic values. Therefore, this technology has been promoted as potential process to recover nutrients from solid organic wastes. Earlier studies indicate the suitability of earth-

worm in decomposition of biomass of kitchen waste (Wani and Mamta, 2013), (Hanc and Pliva, 2013), (Nair *et al.*, 2006), (Tripathi and Bhardwaj, 2004) and (Sinha *et al.*, 2002). It is clear that weed biomass can be utilized potentially in vermicomposting operation. The disposal and meaningful utilization of kitchen wastes is an issue of major concern for municipal solid waste for its transporting costs and the collection location choice. Composting or vermicomposting can be used as efficient technology to convert kitchen wastes into valuable products for soil applications. In terms of nutrient availability and biological, the products of vermicomposting are better than traditional composting operation (Suthar, 2010). As compared to thermal composting, vermicomposting often produces a product with a lower mass, lower processing time, humus content, phyto-toxicity is less likely, more N is released and fertilizer value is usually greater. Moreover, during vermicomposting of organic waste, the interactions between epigeic earthworms and the detrital microbial community lead to decreases in the abundance of some potentially pathogenic microorganisms, especially coliforms (Monroy *et al.*, 2009). Singh *et al.* (2011) presented a detailed review on the integration of the vermicomposting process in a municipal solid waste management system and highlighted its main benefits. These authors emphasize that vermicomposting is odorless, cost effective, produces a product with better nutrient availability than traditional composting, leads to the destruction of pathogenic microorganisms, and results in low greenhouse gas emissions. Although Hait and Tare (2011) stated that the vermicompost production rate depends on the environmental conditions, stocking densities and type of earthworm species apart from the characteristics of waste. Navarro *et al.* (2009); Ndegwa and Thompson

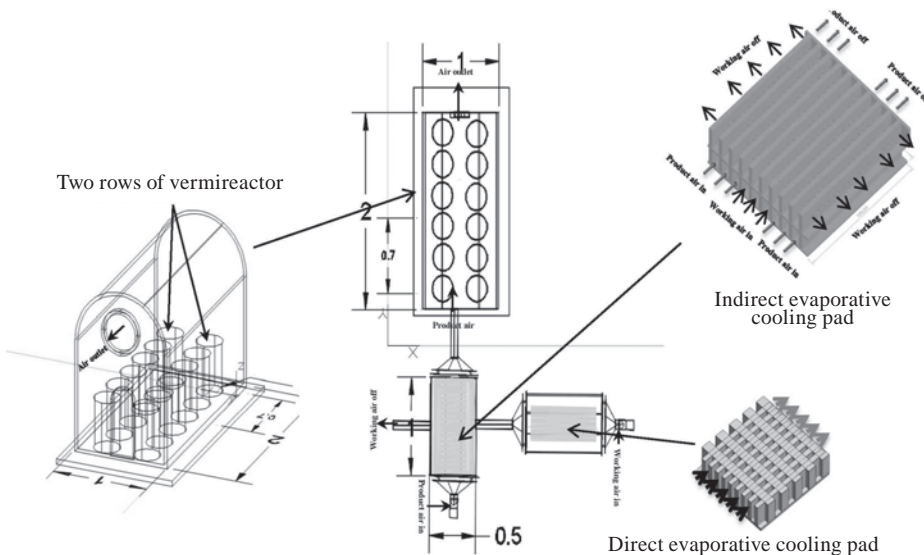
(2000) cultured earthworms *Eisenia foetida* with stocking density of 1.6 kg-worm/m<sup>2</sup> for bio-solids treatments. Meanwhile, Hait and Tare (2011) revealed that the favorable stocking density is in the range of 2.0-4.0 kg/m<sup>2</sup> with the optimum being at 3.0 kg/m<sup>2</sup> as far as the feed (waste) processing is concerned. Jain *et al.* (2003); Hait and Tare (2011) reported that the vermicast production varied 0.20-0.29 g-cast/g-worm/day with *E. foetida* during the vermicomposting of municipal solid waste in modified vermireactor bins. Gajalakshmi *et al.* (2001c) reported a cast production rate of 0.20-0.21 g-cast/g-worm/day in low rate digesters fed on mixture of paper and cow dung employing earthworm species *Eudrilus eugeniae*. A cast production rate of 0.23-0.35 g-cast/g-worm/day with an average value of 0.30 g-cast/g-worm/day has been reported during vermicomposting of source-separated human feces employing *E. foetida* (Yadav *et al.*, 2010). Limit scientific studies of the vermicomposting process on the home scale, as an alternative to traditional waste-management systems in all cities from collecting, transporting and disposing. So taking into consideration environmental conditions, such as air temperature and relative humidity; the using of the technique of evaporative cooling for vermireactors ambient conditioning and product quality, had not been undertaken to date. Home and vermicomposting have been proposed as alternative treatments when discussing sustainable food waste-management options (Barnes and Jerman, 2002; Lundie and Peters, 2005).

The objective of this investigation was to evaluate the vermicomposting process under passive, direct and indirect active evaporative cooling vermireactors with different areal loadings and two different vermireactors as an alternative technique for homely disposal of kitchen wastes in terms of the amount of

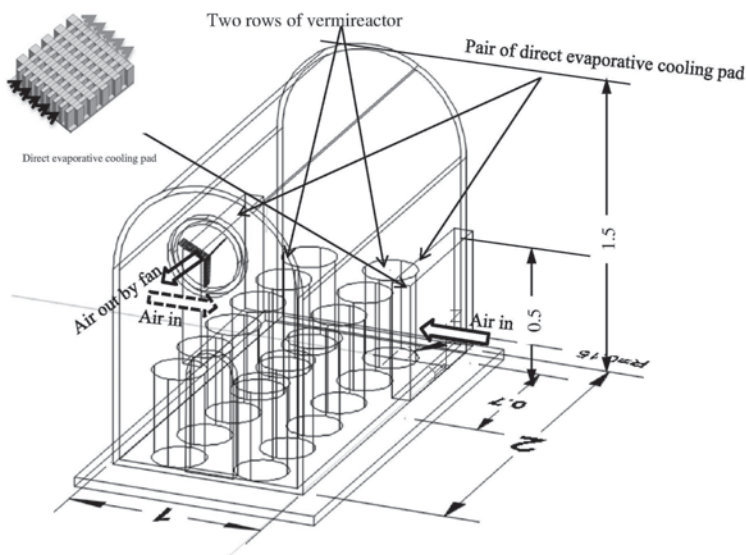
**Fig. 1** Passive evaporative cooling vermicomposter



**Fig. 2** Indirect active evaporative cooling vermicomposter



**Fig. 3** Direct active evaporative cooling vermicomposter



waste that can be diverted from kitchen and evaluating the quality of the end product.

## Materials and Methods

### Experimental Setup

#### *Evaporative cooling vermicomposters and pads installation*

Three different evaporative cooling systems were employed in the present investigation. Two different systems of direct and indirect active evaporative cooling were termed as forced vermicomposters (DEV & IVER) and the third one is called passive evaporative cooling (multi-columns) vermicomposter (PEVR), **Figs. 1, 2 & 3**. To accomplish the group of experiments, the three configurations of vermicomposters were constructed each with its special evaporative cooling pad. The direct evaporative cooling vermicomposter (DEV) consists of Quonset wooden greenhouse of 1.5 m height  $\times$  1 m width  $\times$  2 m long. Two lateral openings were used for direct pads installation of 0.7 m width  $\times$  0.5 m height. Air suction fan of 300 W was used for air discharging from greenhouse inside with airflow rate of 1.88 m<sup>3</sup>/s, therefore, the air was forced to pass through the direct pads carrying moisture used for inside cooling, **Fig. 3**. The indirect evaporative cooling vermicomposter (IEVR) has a greenhouse with the same dimensions of the own DEV, there is no air fan installed at top such DEV but only one exhaust opening for air entering by two fans of 200 W each used for indirect evaporative cooling pad, **Fig. 2**. The pad of IEVR system consists of two parts. The first one is used for air humidification and its function such as the pads of DEV. However, the second one is used as

**Table 1** Experimental design of each evaporative cooling vermicomposter

Manufacture form	Tray depth & Filling depth, respectively, cm	Applied filling compression, Pa	Filling intensity, kg of feed	Areal loading, cm <sup>2</sup> /kg of feed	Initial stocking density, worms number
With five trays	9 & 7	0	0.950/Tr	743.70	190/Tr
With five trays	9 & 7	392.4	1.500/Tr	471.00	190/Tr
With five trays	9 & 7	784.8	1.667/Tr	423.80	190/Tr
Without trays	50 & 35	0	3.333/Re	211.97	950/Re
Without trays	50 & 35	392.4	4.457/Re	158.51	950/Re
Without trays	50 & 35	784.4	5.267/Re	134.14	950/Re

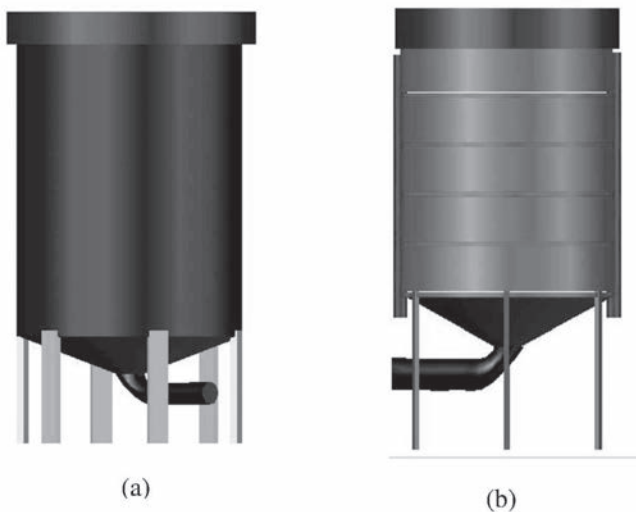
perpendicular heat exchanger, obtaining chilled air without moisture. The pads of DEVR and IEVR are stand at the opening of air entering or stand separately as columns in PEVR. The total pad volume was of 0.35 m<sup>3</sup> (0.7 × 0.5 × 0.5 m) and it was identical for the three pad configurations under study. Meanwhile, for the multi-columns pad, its total volume was divided into twenty nine equal columns of 0.012 m<sup>3</sup> (radius of 0.062 m and 1 m height). The rice straw was used as a pad material for all evaporative cooling vermicomposters. The density of pad material was kept constant at about 32 kg/m<sup>3</sup> in accordance with Hellickson and walker, 1983 for all pads. It was determined by knowing pad volume multiplying it by its density of 32 kg rice straw. Rice straw was uniformly distributed between two wires net. Water flow rate of pad was of about 0.259 m<sup>3</sup>/h

and it was kept constant at this value for all pads. It was selected in accordance with Wiersma and Benham, 1974. Pad material manufacturing and constructing was in accordance with Basiouny and Abdallah, 2013. The system of supplying water to the vertical pad was fulfilled by using a perforated pipe, which was positioned above the pad through its longitudinal axis. The system of supplying water to the pad was constructed from water tank and a small pump attached with the tank for the purpose of pumping water to the pad. The water flow rate was controlled by a hand valve.

#### Vermireactors Construction and their Filling Methods

Two types of vermireactors (with trays and without trays) were investigated, **Fig. 4**. For experimental studying, thirty six vermireactors were used, consisted of three groups

of six vermireactors for three different evaporative cooling vermireactors (Passive, direct active and indirect active) are indicated in **Table 1** with their replicates. The vermireactor without trays consists of cylindrical shell of galvanic steel with pierced lid for aeration with two principal chambers; one metal mesh (5 mm pore size) separates between them; the first one only has one space for vermicomposting process with 0.45 m height and the beneath chamber with 0.05 m height is used for leachate collection (0.3 m diameter and 0.05 m in depth). The vermibed is placed over the plastic mesh in 35 cm depth. The other vermireactor with trays has the same dimensions of the above but the vermicomposting chamber is divided into multi spaces by five trays with 0.09 m in depth and 0.3 m in diameter and let 0.02 m as a void. The reactors were operated in a pseudo-discretized continuous mode, standardized and extensively reported earlier by the authors (Gajalakshmi *et al.*, 2001 a,b, 2002, 2005 a,b; Gajalakshmi and Abbasi, 2003, 2004 a,b). In this mode, the reactor contents were removed once every seven days, to assess vermicast production, cocoon and hatchling formation, mortality, etc. The 'parent' worms were picked up, counted to check if there was any mortality, were washed and blotted dry for weighing, and then immediately put back in the reactors which were restarted with fresh feed. Three different densities of kitchen waste were studied and obtained by different filling compression forces.

**Fig. 4** Vermireactors (a) without trays and (b) with trays

The first vermireactor was used as a control, loose filling (without compression). However, the other two vermireactors were pressed at 392.4 Pa (0.004 kgf/cm<sup>2</sup>) and 784.8 Pa (0.008 kgf/cm<sup>2</sup>) that equivalent different areal loadings. Concerning the vermireactors without trays, the filling compression forces were applied once on the upper surface of the whole vermireactor waste content.

## Experimental Procedure

### Preparation of Vermibeds

The kitchen bio-wastes were composed of leftovers of fruit and vegetables, this material was obtained from a kitchen in Baltimore, Kafr Elsheikh governorate, Egypt during spring season of the year 2014. Additionally, a small amount of cooked pasta, rice and bread was added up to 33 % of the total kitchen bio-waste. Kitchen bio-wastes were dried in solar drier achieving approximately moisture

content of 60 % wet basis, chopped and sieved (< 2 mm). The air-dried kitchen bio-waste was amended with wheat straw by one part of wheat straw to two parts of kitchen bio-wastes for vermibed producing. All beddings were kept in plastic containers (100 cm × 100 cm × 90 cm) for three weeks prior to experimentation for thermal stabilization, initiation of microbial degradation and softening of waste (Nair *et al.*, 2006). To prevent desiccation, appropriate moisture (65 % wet basis) was maintained during this duration by periodically sprinkling of an adequate quantity of water. The waste mixture in different beddings was turned over periodically (after three days) for aeration and to remove odor from decomposing wastes. After initial thermal stabilization of composting beds, the composted material was used to fill each vermireactor for further vermicomposting experimentations. Bulking material selection and beddings preparation was set in accordance with Suthar (2009). To start the experiment, the

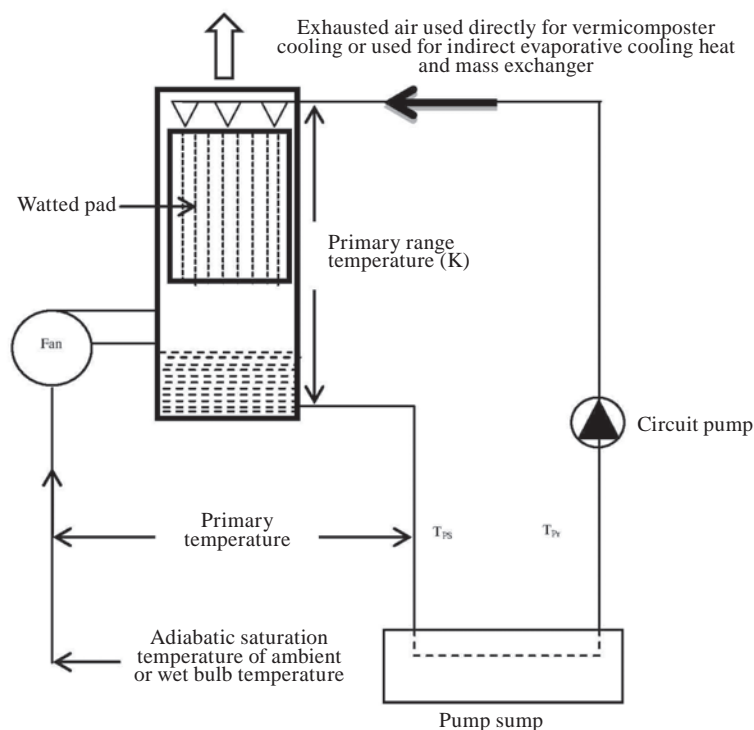
earthworms species *E. foetida* (Savigny) were obtained from a stock culture reared in Central Laboratory of Agricultural Climate (CLAC), Agricultural Research Center, Ministry of Agriculture, Dokki, Giza, Egypt, and were mixed with humidified vermibed. A significant increase in the number and size of the earthworms was observed. Leachate was collected on a weekly basis.

The active evaporative cooling unit (Fig. 5) includes two main elements, the water spray nozzles with orifice dimension 0.3 mm (TANONG PRECISION TECHNOLOGY CO., LTD., TAIWAN) or a simple tray tube type distributor, and the packing material. The spray nozzles were selected to generate a conical pattern of fine mist. The nozzles were arranged in a square or triangular pitch with proper spacing that provided complete wetting of the packing surface. Proper operation of the spray nozzles requires sufficient amounts of water and delivery pressure. The simple tray tube type distributor has a perforated base through which a continuous stream of fine water droplets flows over the top surface of the packing material. The wetting efficiency of the top surface of the packing material for the simple tray tube distributor may not be as efficient as the water spray nozzles. However, operation of this system did not require a certain feed water pressure and its construction and maintenance are much simpler than the spray nozzle system.

### Evaporative Cooling System

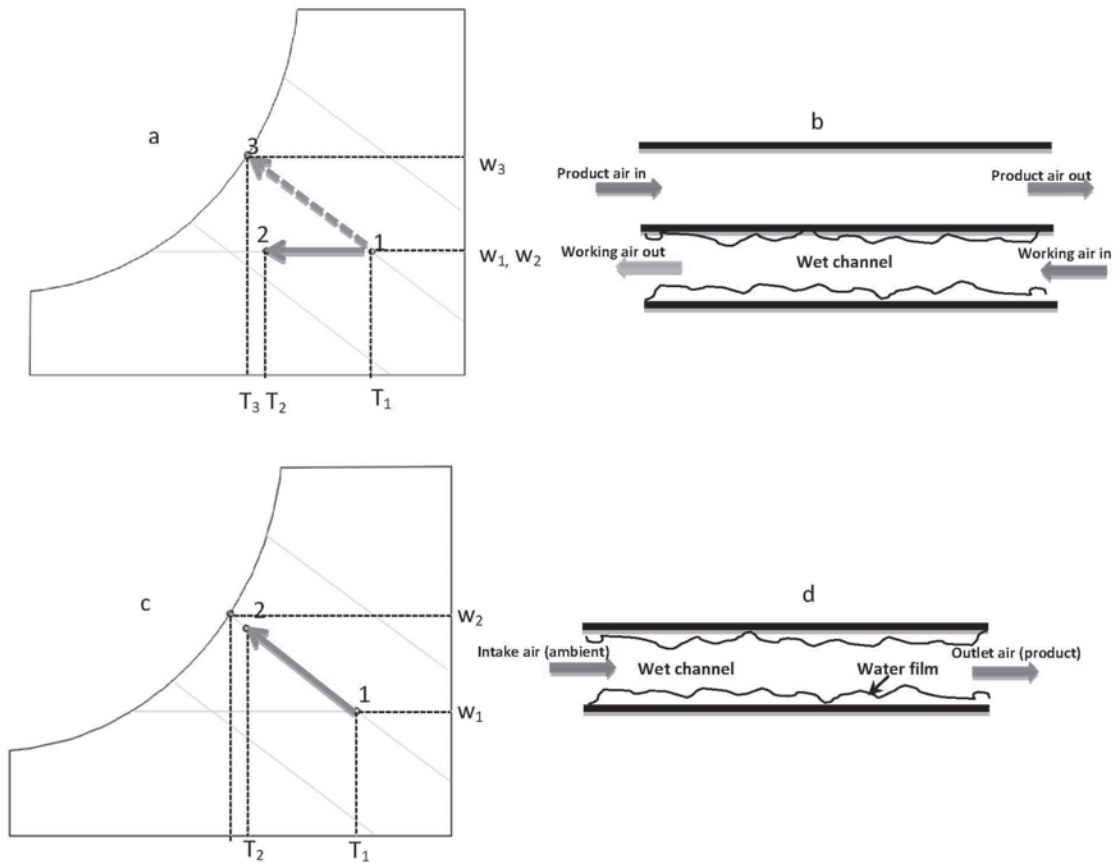
Direct active evaporative cooling systems decrease air temperatures by moisture carrying from the pads, but indirect active evaporative cooling systems can lower air temperature without adding moisture into the air, making them the more attractive option over the direct ones. In the indirect active evaporative cooling system, the primary (product) air passes over the dry side of a

Fig. 5 Simplified schematic of a water-side active evaporative cooling unit

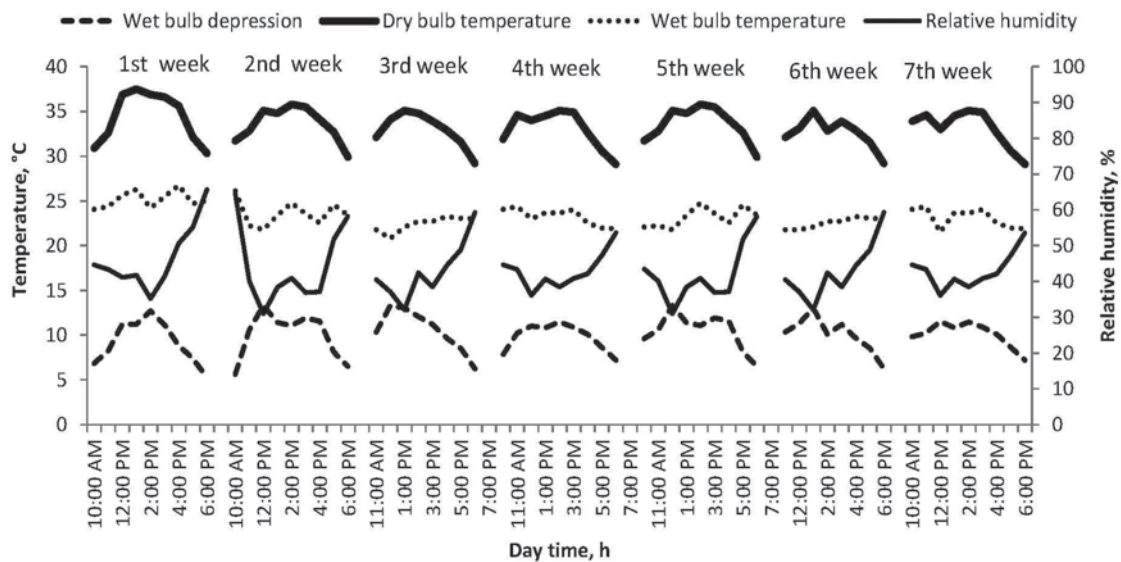




**Fig. 6** Evaporative cooling heat and mass exchanger (b, d). Working principle of both indirect and direct evaporative cooling, respectively (a, c). Psychrometric illustration of the air treatment process in both indirect and evaporative cooling heat and mass exchanger, respectively



**Fig. 7** Experimental weather conditions during April & May 2014





plate, and the secondary (working) air passes over the opposite wet side. The wet side air absorbs heat from the dry side air with aid of water evaporation on the wet surface of the plate and thus cools the dry side air; while the latent heat of the vaporized water is transmitted into the working air in the wet side, **Fig. 6**.

### Finished Vermicompost Analyses

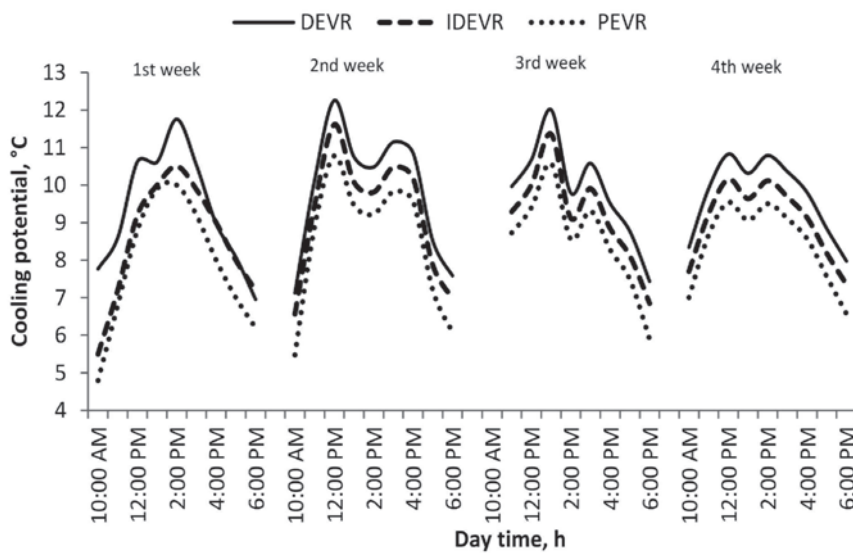
Chemical and mineral analyses for representative samples of finished vermicompost were carried out according to the standard procedures of the official methods (AOAC, 1980). All of those analyses were conducted in the Animal Production Research Laboratories (APRL), Sakha, Kafr Elsheikh governorate, Egypt.

## Results and Discussion

### Weather Conditions during Measurement Period

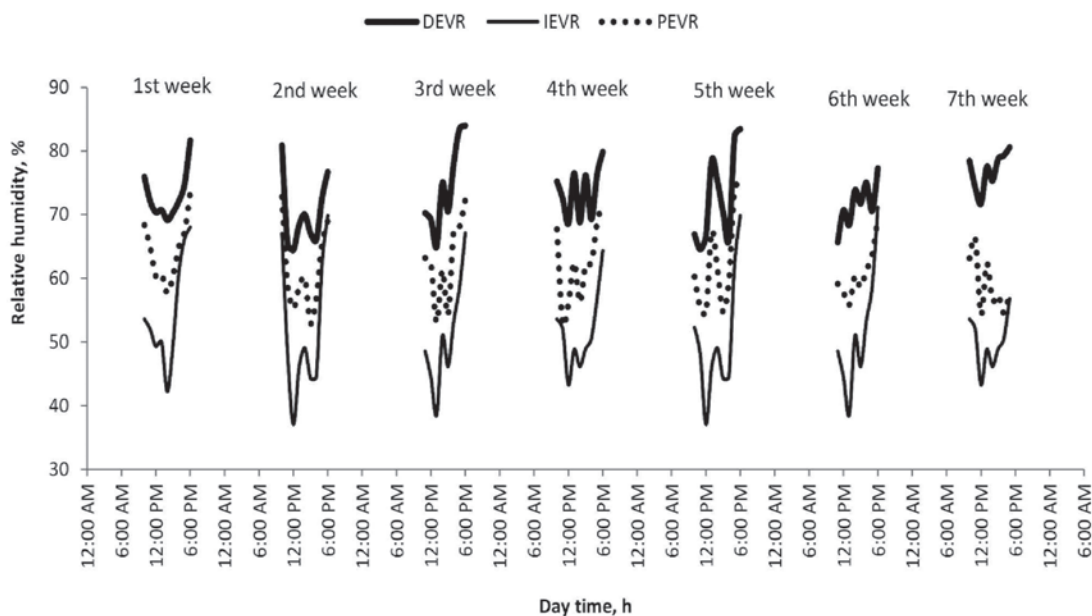
**Fig. 7** shows the average of weather conditions each week of relative humidity, dry bulb temperature and wet bulb temperature during the experiment. Daily total horizontal solar radiation was nearly similar during the experiment, its maximum value ranged from 861.26 and 879.81 W/m<sup>2</sup> at 12:00 PM. Relative humidity has its maximum value of 65.6 % at 6:00 PM and temperature of 30.3 °C and its minimum value of 36.9 % at 1:00 PM. Wet-bulb depression measured the difference between the dry-bulb and the wet-bulb temperature which determines the humidity level.

**Fig. 8** Cooling potential and relative humidity of the vermicomposters



### Cooling Potential and Relative Humidity of the Vermicomposters

Temperature reduction was determined to describe the cooling potential of the investigated vermicomposters, **Fig. 8**. The average variation of cooling potential and relative humidity throughout a week as affected by daytime is depicted in **Fig. 8**. The direct evaporative cool-



**Table 2** Indirect active evaporative cooling vermicomposter

Total biomass, g		Growth rate, mg day <sup>-1</sup> worm <sup>-1</sup>	Cocoon, earthworm <sup>-1</sup> Week <sup>-1</sup>	Stocking density, mg biomass cm <sup>-1</sup>		Mean earthworm biomass change, %
Initial	Final			Initial	Final	
141.8/Tr	312.4/Tr	20.98 ± 2.47	2.0 ± 0.42	28.67	63.16	120.3
138.5/Tr	285.3/Tr	18.48 ± 2.63	1.3 ± 0.26	28.00	57.69	106.0
132.2/Tr	243.4/Tr	13.75 ± 2.16	0.68 ± 0.12	26.74	49.23	84.12
645.8/Re	1126.7/Re	11.42 ± 2.47	0.5 ± 0.07	26.12	45.56	74.50
632.5/Re	1007.6/Re	9.44 ± 1.97	0.73 ± 0.09	25.58	40.75	59.30
583.3/Re	663.1/Re	2.01 ± 0.42	0.2 ± 0.08	23.59	26.82	13.68

**Table 3** Direct active evaporative cooling vermicomposter

Total biomass, g		Growth rate, mg day <sup>-1</sup> worm <sup>-1</sup>	Cocoon, earthworm <sup>-1</sup> Week <sup>-1</sup>	Stocking density, mg biomass cm <sup>-1</sup>		Mean earthworm biomass change, %
Initial	Final			Initial	Final	
145.0/Tr	331.6/ Tr	23.37 ± 2.50	2.21 ± 0.27	29.34	67.05	128.53
142.0/ Tr	309.8/ Tr	21.03 ± 2.60	1.43 ± 0.17	28.71	62.64	118.18
135.1/ Tr	261.7/ Tr	15.86 ± 2.22	0.74 ± 0.12	27.32	52.91	93.67
662.2/Re	1215.6/ Re	13.87 ± 2.38	0.53 ± 0.08	26.8	49.16	83.43
645.6/ Re	1099.3/ Re	11.37 ± 1.77	0.77 ± 0.06	26.11	44.46	70.28
586.1/ Re	682.7/ Re	2.42 ± 0.44	0.24 ± 0.05	23.70	27.61	16.50

**Table 4** Passive evaporative cooling vermicomposter

Total biomass, g		Growth rate, mg day <sup>-1</sup> worm <sup>-1</sup>	Cocoon, earthworm <sup>-1</sup> Week <sup>-1</sup>	Stocking density, mg biomass cm <sup>-1</sup>		Mean earthworm biomass change, %
Initial	Final			Initial	Final	
138.5/ Tr	285.6/ Tr	18.43 ± 1.95	1.58 ± 0.37	28.01	57.75	106.18
135/ Tr	260.8/ Tr	15.77 ± 2.03	1.04 ± 0.23	27.29	52.74	93.26
129.3/Tr	221.4/ Tr	11.54 ± 2.13	0.56 ± 0.11	26.15	44.78	71.24
629.4/ Re	985.7/ Re	8.93 ± 2.35	0.43 ± 0.06	25.45	39.86	56.62
619.4/ Re	915.9/ Re	7.43 ± 1.92	0.64 ± 0.08	25.05	37.04	47.86
580.5/ Re	643.5/ Re	1.58 ± 0.47	0.12 ± 0.07	23.48	26.03	10.86

ing vermicomposter has the highest values of temperature reduction and relative humidity if compared with the two other vermicomposters. As well as, the highest values of cooling potential were noticed in the period of 12:00 PM to 4:00 PM. Relative humidity values of direct evaporative cooling vermicomposter fluctuated between 70 and 80 % recommended by Hait and Tare (2011); only this range can be obtained by DEVR.

#### Earthworm Growth Rate

*E. fetida* showed excellent patterns of biomass gain and cocoon productions in all vermireactors during the vermicomposting process. There was a significant difference among vermireactors for maximum individual biomass ( $P < 0.01$ ) and total biomass gain ( $P < 0.01$ ).

The maximum individual growth rate ( $23.37 \pm 2.50$  mg worm<sup>-1</sup> day<sup>-1</sup>) was achieved by DEVR. Earthworms showed maximum and minimum individual biomass 1.75 g and 0.611 g, respectively. The trends of mass gains in individual earthworms are indicated in **Tables 2, 3 & 4**. Data clearly suggested that earthworm biomass gain was the highest in vermireactors with trays with the lowest filling intensity of 0.95 kg of feed/tray and the highest areal loading of 743.70 cm<sup>2</sup>/kg due to the highest porosity achieved in this treatment that introduced the sufficient aeration for earthworms. The vermireactors of DEVR showed rapid earthworm biomass change of 128.53 %, while in other vermireactors the earthworm biomass change was slightly low.

The vermicomposter type, ver-

mireactor configuration and filling intensity showed statistically significant ( $p < 0.01$ ) effect on earthworm total biomass. **Fig. 9** shows that areal loading of 743.7 cm<sup>2</sup>/kg feed has the highest trend of total biomass increasing from 708.99 to 1561.9 g, from 725.41 to 1657.87g and from 692.56 to 1427.92 g of IEVR, DEVR and PEVR, respectively.

The effects of vermireactor configuration and stocking densities on the offspring production are presented in **Tables 1, 2 and 3**. It has been shown that earthworm reproduction and copulation frequency are greatly influenced by the temperature and moisture level (Hand, 1988). The population density also influences the earthworm reproduction. The copulation frequency is high at low population densities especially at the first four weeks and

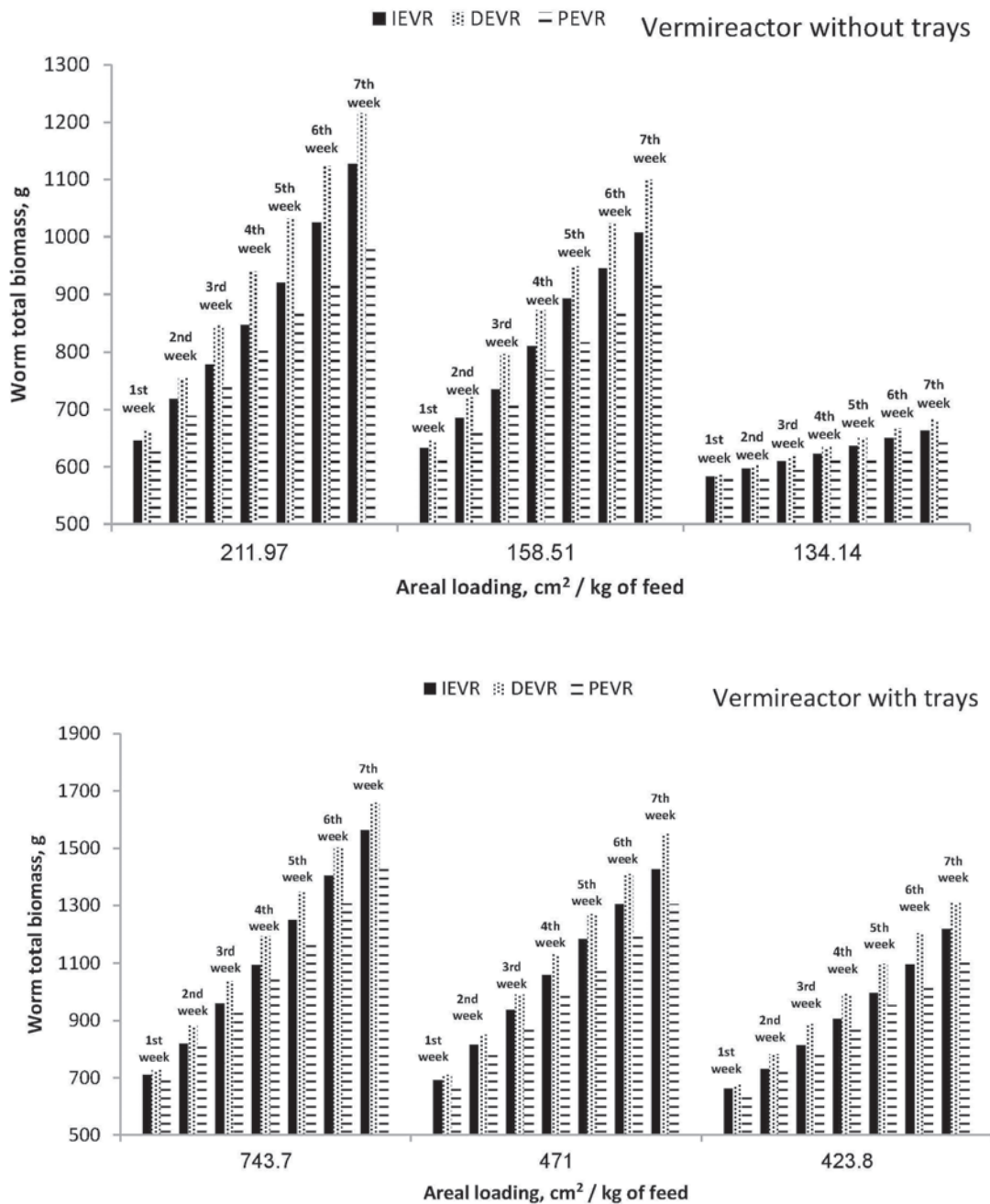
it decreases notably when density approaches the carrying capacity of the system. It was observed in the present study that the offspring production was high at lower densities and decreased with increasing density. The cocoon production was in the range of 0.10-2.50 number/worm.

### Vermicast Production

In all the vermireactors, the earthworms grew well, increasing their mass by more than 128.53 %. This trend, which followed the efficiency of vermicast production, was also shown in terms of reproductive ability as measured by the number of offspring produced. Total mass of

cast was estimated and daily cast production rate per worm was calculated based on the weekly cast production. The vermireactors clearly manifest the trend of increasing output with increasing surface: volume ratio. The statistical significance of these differences was determined by Student's t-test (Sharma, 2003). The

**Fig. 9** Total biomass of earthworm of the IVER, DEVR and PEVR during the experimental duration for the two types of vermireactors

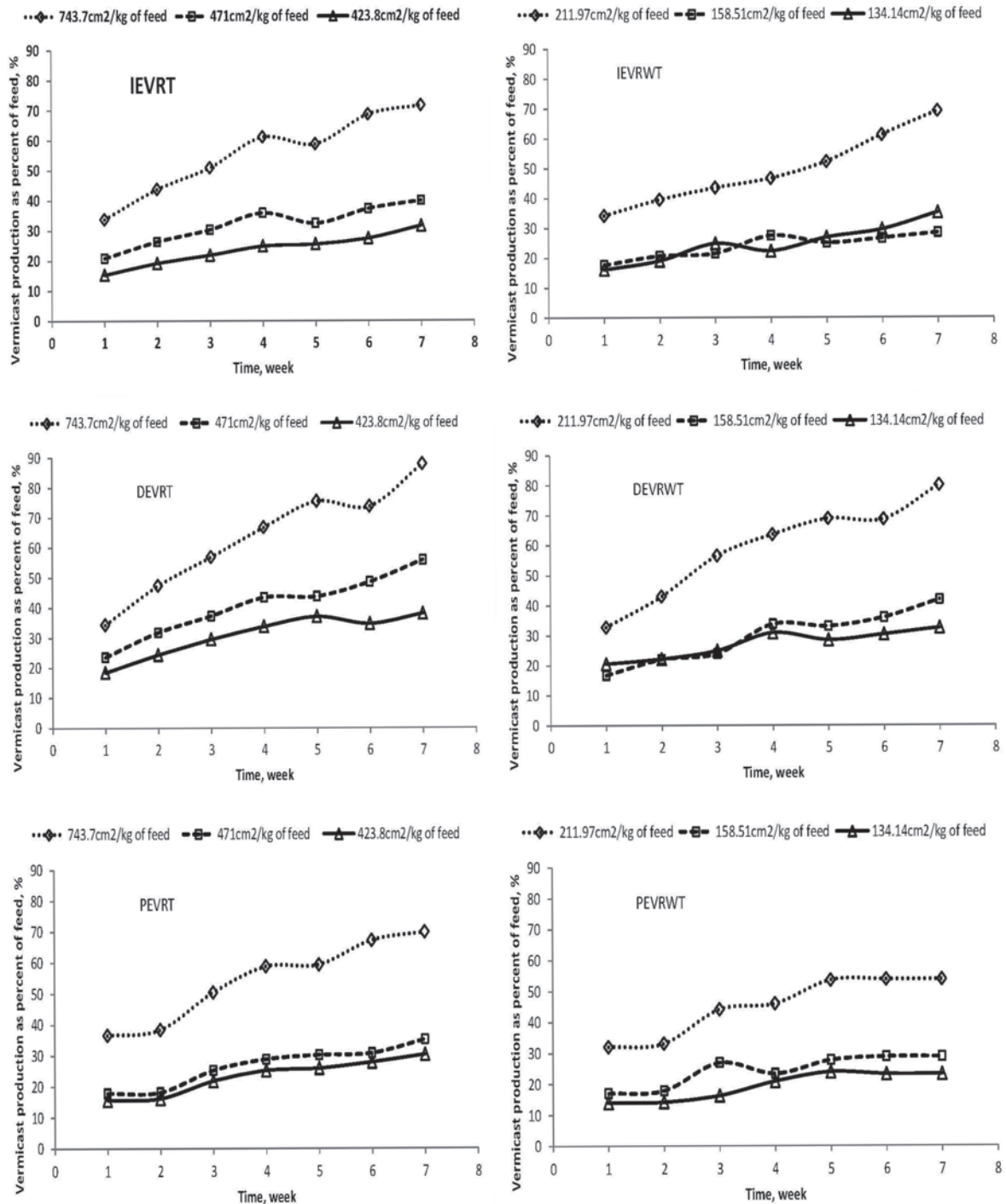


analysis revealed that the output of the vermireactors with trays with surface area of 743.70 cm<sup>2</sup>/kg of feed was higher than the output of the vermireactors without trays with

surface area of 211.97 cm<sup>2</sup>/kg of feed (the two vermireactors have the same amount of feed) at 99 % confidence level (P < 0.01). The vermicast production as a percent of feed

was increased rapidly in the direct evaporative cooling vermireactors with trays (DEVRT) from 34.30 to 87.80 %, from 23.52 to 55.83 % and from 18.40 to 38.00 % at areal load-

**Fig. 10** Vermicast generated as percent of feed under different areal loading, three different evaporative cooling vermireactors and two different vermireactors

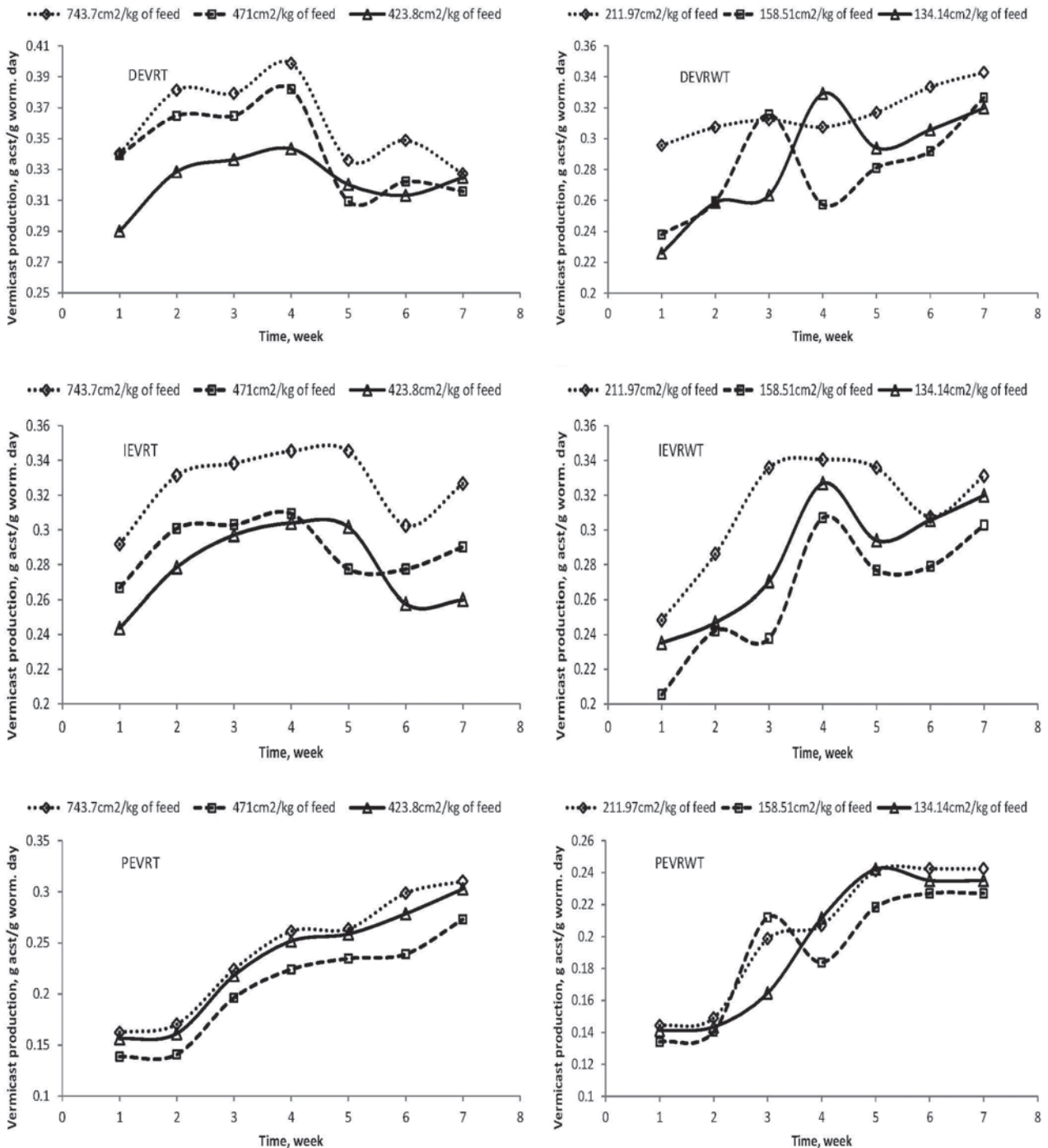


ings of 743.7, 471.0 and 423.8 cm<sup>2</sup>/kg of feed, respectively. In turn, the output of the vermireactors with areal loading of 471.0 cm<sup>2</sup>/kg of feed was higher than the output of the

reactor with areal loading of 423.8 cm<sup>2</sup>/kg of feed, also at 99 % confidence level, Fig. 10. In terms of areal loading, greater the surface area per unit mass of the feed, higher is

the vermicast output (Figs. 10 and 11). The earthworm mortality accompanying each run and the average change in each run was consistently low indicating that the worms

**Fig. 11** Vermicast produced for each gram of earthworm per day under different areal loadings, three different evaporative cooling vermicomposters and two different vermireactors



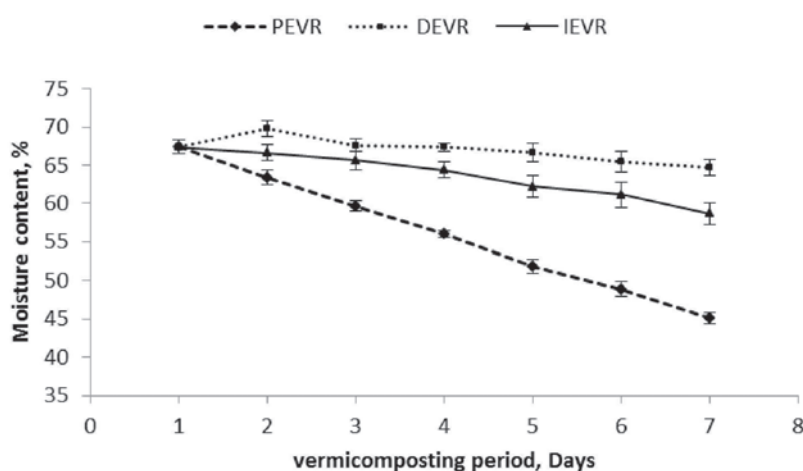


fed voraciously (Gajalakshmi *et al.*, 2002, 2005 a, b; Gajalakshmi and Abbasi, 2003, 2004a). In DEVR vermicast produced by each gram of worm increased until the fourth week, from this moment it dropped dramatically due to *E. fetida* showed individual mean mass increase up to 1.315 g/each worm, generating some competition on nutrition simultaneously with the increment of microbial populations; thereafter, a trend of stabilization was observed until the end. In all vermireactors of passive evaporative cooling vermicomposters, i.e., PEVRT and PEVRWT at different areal loadings,

*E. fetida* exhibited slow biomass increase by the end of experimentation. The difference could be attributed to lower cooling potential of the passive evaporative cooling vermicomposter as well as relative humidity, **Fig. 9**. Suthar (2008a,b) suggested that the growth pattern in composting earthworm depends on microbial populations and nutrient pool. Cast production rate is an important aspect for vermicomposting evaluation. The cast production rate was found varying in the range of 0.12-0.40 g-cast/g-worm/day as illustrated in **Fig. 11**. The maximum vermicompost production rate was

observed in experimental vermireactors with trays of DEVR and areal loading of 743.7 cm<sup>2</sup>/kg of feed (0.40 g-cast/g-worm/day), at the fourth week, whereas vermireactors without trays and areal loading of 158.5 cm<sup>2</sup>/kg of feed (0.138 g-cast/g-worm/day) showed the minimum cast production rate at the first week. The three vermicomposters and vermireactor type as well as areal loading had significant (P < 0.05) effects on the cast production rate. The cast production rate in the present study is in good agreement with the results reported by (Jain *et al.* 2003; Hait and Tare 2011; Gajalakshmi *et al.* 2001c and Yadav *et al.*, 2010). It has been also observed that the net cast production (g-cast / g-worm/day) at DEVRT and IEVRT was nearly constant except during the first week for adaptation as compared to other vermireactors and thereby indicating that the cast production per each worm reached its maximum production with stocking densities up to 57 mg/cm<sup>3</sup> (3.99 kg/m<sup>2</sup>) and suddenly dropped in the fifth week of DEVRT and sixth week of IEVR, but the other vermireactors the individual growth rate was notably slow and did not reach stocking densities over 4.0 kg/m<sup>2</sup>. This can be explained by the fact that overcrowding of worms had undesirable effects on vermicomposting process even under favorable environmental conditions (Dominguez and Edwards, 1997). In the context of the present study, it can be inferred that the favorable environmental conditions are in direct evaporative cooling vermicomposter with optimum being at vermireactors with trays and areal loading of 743.7 cm<sup>2</sup>/kg of feed (i.e. temperature: 20-27 °C and RH: 70-80 %), whereas the favorable stocking density is in the range of 2.0-4.0 kg/m<sup>2</sup> with the optimum being at 3.0 kg/m<sup>2</sup> as far as the feed (waste) processing is concerned. It is observed that the evaporative cooling vermicomposter type play an important role on feed's moisture

**Fig. 12** Characterization of the final products, compost quality standards is also reported for reference



**Table 5** Characterization of the final products, compost quality standards is also reported for reference

Properties	Vermicast	Compost quality standards
Moisture (% wb)	50.3	30-40
Organic matter (% db)	75	> 35
pH (extract 1 : 5 w : v)	8.97	6.5-8
Electrical conductivity (extract 1:5 w:v) (mS cm <sup>-1</sup> )	1.72	≤ 6
N-Kjeldahl (% db)	1.66	≥ 2
Dynamic Respiration Index (mg O <sub>2</sub> g <sup>-1</sup> OM h <sup>-1</sup> )	0.43	0.5-1.5
Escherichia coli (CFU/g)	< 10	< 10
Zn	220	200-1000
Cu	100	70-400
Ni	37	25-100
Cr	180	70-300
Pb	50.5	45-200
Cd	2	0.7-3

wb: wet basis; db: dry basis; w: weight; v: volume; OM: organic matter

content. To study this option one plate let aerobically exposed inside each vermicomposter type. **Fig. 12** shows the effect of each vermicomposter type on feed's moisture content, and the direct one DEVR has the highest control on feed's moisture content.

### Vermicompost Properties Analysis

**Table 5** presents the characteristics of the final products obtained and the compost quality standards for composts produced industrially (Lleó *et al.*, 2013). There are no standard values for products obtained at home, which are expected to be used in the producers' own gardens. The properties of the vermicast were found to be within the compost quality limits, except for moisture content, which exceeded the proposed values. This exceedance of moisture content is inherent to the process when the process is conducted on a small scale in a closed bin. The aeration of the bin is minimal and no heat is generated during the process, making moisture removal difficult and sometimes undesirable for the earthworms. The vermireactor valve used for leachate removal was left in the open position to facilitate air circulation through the decomposing material. The final product was sanitary tested negative for *Salmonella* and *Escherichia coli* under the limits outlined in legislation.

### Conclusions

Three different evaporative cooling vermicomposters were evaluated as ambient conditioning for kitchen bio-waste conversion by earthworms with two configurations of vermireactors. The optimum treatment obtained with areal loading of 743.7 cm<sup>2</sup>/kg of feed (filling intensity of 0.95 kg/tray) with vermireactor with trays with initial stocking density of 23mg/cm<sup>3</sup> (190worms/tray) up to 57 mg/cm<sup>3</sup>. Direct active evapora-

tive cooling vermicomposter has the highest ability for earthworm ambient conditioning; relative humidity can be maintained in the range from 70-80 % and air temperatures from 20 to 27 °C, that was found favorable for ambient earthworm. The engineering treatments produced the highest growth rate of *E. fetida* in direct active evaporative cooling vermicomposter by the vermireactor with trays of 23.37 ± 2.50mg/cm<sup>3</sup>. Vermicast production as percent of feed increased from 31.18 to 87.8 % from 1st week to the 7th week, respectively. Vermicast production per each gram worm per day was in the range of 0.12-0.40g-cast/g-worm/day depending on the state of earthworms stocking densities which presented the appropriate chance for each worm for feeding up to 57 mg/cm<sup>3</sup> (3.99kg/m<sup>2</sup>). A good quality vermicompost product has been obtained from evaporative cooling vermicomposter on a small scale which was analyzed and compared with compost quality standards.

### REFERENCES

- Aira, M., F. Monroy, and J. Dominguez. 2007. *Eisenia fetida* (Oligochaeta: Lumbricidae) modifies the structure and physiological capabilities of microbial communities improving carbon mineralization during vermicomposting of pig manure. *Microb. Ecol.* 54: 662-671.
- AOAC. 1980. Official methods of analysis (13th Ed.). Association of Official Analytical Chemists, Washington, D. C., USA.
- Bardos, R. P. and J. P. Lopez-Real. 1991. The composting process: susceptible feedstocks, temperature, microbiology, sanitization and decomposition. In: Bidlingmaier, W., L'Hermite, P. (Eds.), *Compost Processes in Waste Management*. European Community: 179-190.
- Barnes, P. and P. Jerman. 2002. Developing an environmental management system for a multiple-university consortium. *Journal of Cleaner Production* 10: 33-39.
- Basiouny, M. A. and S. E. Abdallah. 2013. Influence of pad configuration on evaporative cooling system effectiveness inside a wind tunnel. *AMA-Agricultural Mechanization in Asia, Africa and Latin America*, 44(4): 70-81.
- Dominguez, J. 2004. State-of-the art and new perspectives on vermicomposting research. In: Edwards, C.A. (Ed.), *Earthworm Ecology*, 2nd ed. CRC Press: 401-424.
- Dominguez, J., C. A. Edwards. 1997. Effects of stocking rate and moisture content on the growth and maturation of *Eisenia andrei* (Oligochaeta) in pig manure. *Soil Biol. Biochem.* 29: 743-746.
- Eastman, B. R., P. N. Kane, C. A. Edwards, L. Trytek, B. Gunadi, A. L. Stermer, and J. R. Mobley. 2001. The effectiveness of vermiculture in human pathogen reduction for USEPA biosolids stabilization. *Compost Science and Utilization*, 9(1): 38-49.
- Eghball, B., J. F. Power, J. E. Gilley, and J. W. Doran. 1997. Nutrient, carbon, and mass loss during composting of beef cattle feedlot manure. *J. Environ. Qual.* 26: 189-193.
- Gajalakshmi, S. and S. A. Abbasi. 2003. High-rate vermicomposting systems for recycling paper waste. *Indian Journal of Biotechnology*, 2: 613-615.
- Gajalakshmi, S. and S. A. Abbasi. 2004a. Neem leaves as a source of fertilizer-cumpesticide vermicompost. *Bioresource Technology* 92: 291-296.
- Gajalakshmi, S. and S. A. Abbasi. 2004b. Vermiconversion of paper waste by earthworm born and grown in the waste-fed reactors compared to the pioneers raised to adulthood on cowdung feed. *Bioresource Technology* 94: 53-56.

- Gajalakshmi, S., E. V. Ramasamy, and S. A. Abbasi. 2001a. Potential of two epigeic and two anecic earthworm species in vermicomposting water hyacinth. *Biore-source Technology* 76: 177-181.
- Gajalakshmi, S., E. V. Ramasamy, and S. A. Abbasi. 2001b. Assessment of sustainable vermiconversion of water hyacinth at different reactor efficiencies employing *Eudrilus eugeniae* Kinberg. *Biore-source Technology* 80: 131-135.
- Gajalakshmi, S., E. V. Ramasamy, and S. A. Abbasi. 2001c. Towards maximising output from vermireactors fed with cow dung and spiked paper waste. *Bioresour. Technol.* 79(1): 67-72.
- Gajalakshmi, S., E. V. Ramasamy, and S. A. Abbasi. 2002. High-rate composting –vermicomposting of water hyacinth (*Eichhornia crassipes*, Mart Solms). *Biore-source Technology* 83: 235-239.
- Gajalakshmi, S., E. V. Ramasamy, and S. A. Abbasi. 2005a. Composting –vermicomposting of leaf litter ensuing from the trees of mango (*Mangifera indica*). *Biore-source Technology* 96: 1057-1061.
- Gajalakshmi, S., P. Sankar Ganesh, and S. A. Abbasi. 2005b. A highly cost-effective simplification in the design of fast-paced vermireactors based on epigeic earthworms. *Biochemical Engineering Journal* 22: 111-116.
- Gomez-Brandon, M., M. Aira, M. Lores, and J. Dominguez. 2011. Changes in microbial community structure and function during vermicomposting of pig slurry. *Bioresour. Technol.* 102: 4171-4178.
- Hait, S. and V. Tare. 2011. Optimizing vermistabilization of waste activated sludge using vermicompost as bulking material. *Waste Manage.* 31: 502-511.
- Hanc, A. and P. Pliva. 2013. Vermicomposting technology as a tool for nutrient recovery from kitchen bio-waste. *J. Mater. Cycles Waste Manage.* 15: 431-439.
- Hand, P. 1988. Earthworm biotechnology (vermicomposting). In: Green shields, R. (Ed.), *Resources and Applications of Biotechnology*. The Macmillan Press Ltd., London: 49-58.
- Hellickson, M. A. and J. N. Walker. 1983. Ventilation of agricultural structures. ASAE. Joseph St., Michigan, 49085.
- Jain, K., J. Singh, and S. K. Gupta. 2003. Development of a modified vermireactor for efficient vermicomposting: a laboratory scale study. *Bioresour. Technol.* 90(3): 335-337.
- Khwhairakpam, M. and R. Bhargava. 2009. Bioconversion of filter mud using vermicomposting employing two exotic and one local earthworm species. *Biore-source Technology* 100: 5846-5852.
- Lleó, T., E. Albacete, R. Barrena, X. Font, A. Artola, and A. Sanchez. 2013. Home and vermicomposting as sustainable options for biowaste management. *Journal of cleaner production*, 47: 70-76.
- Lundie, S. and G. M. Peters. 2005. Life cycle assessment of food waste management options. *Journal of Cleaner Production* 13: 275-286.
- Lung, A. J., C. M. Lin, J. M. Kim, M. R. Marshall, R. Nordstedt, N. P. Thompson, and C. I. Wei. 2001. Destruction of *Escherichia coli* O157:H7 and *Salmonella enteritidis* in cow manure composting. *J. Food Protect.* 64: 1309-1314.
- Maboeta, M. S. and L. van Rensburg. 2003. Vermicomposting of industrially produced wood chips and sewage sludge using *E. foetida*. *Ecotoxicol. Environ. Saf.* 56(2): 256-270.
- Monroy, F., M. Aira, and J. Dominguez. 2008. Changes in density of nematodes, protozoa and total coliforms after transit through the gut of four epigeic earthworms (*Oligochaeta*). *Appl. Soil Ecol.* 39: 127-132.
- Monroy, F., M. Aira, and J. Dominguez. 2009. Reduction of total coliform numbers during vermicomposting is caused by short-term direct effects of earthworms on microorganisms and depends on the dose of application of pig slurry. *Science of the Total Environment* 407 (20): 5411-5416.
- Nair J, V. Sekiozoic, and M. Anda. 2006. Effect of pre-composting on vermicomposting of kitchen waste. *Bioresour Technol* 97: 2091-2095.
- Navarro, A. R., L. Dorado, and M. C. Maldonado. 2009. An eco-biotechnological process for the treatment of residual lemon pulp. *Clean Techn Environ Policy*, 11: 323-327.
- Ndegwa, P. M. and S. A. Thompson. 2000. Effects of C-to-N ratio on vermicomposting of biosolids. *Biore-source Technology*, 75: 7-12.
- Sharma, K. 2003. *Statistical Methods*. ABD Publications, Jaipur, India.
- Singh R. P., A. Embrandiri, M. H. Ibrahim, and N. Esa. 2011. Management of biomass residues generated from palm oil mill, vermicomposting a sustainable option. *Resour Conserv Recy* 55: 423-434.
- Singh, R. P., P. Singh, A. S. F. Araujo, M. H. Ibrahim, O. Sulaiman. 2011. Management of urban solid waste: vermicomposting as a sustainable option. *Resources, Conservation and Recycling* 55: 719-729.
- Sinha, R. K., S. Agarwal, K. Chauhan, V. Chandran, and B. K. Soni. 2010. Vermiculture technology: reviving the dreams of Sir Charles Darwin for scientific use of earthworms in sustainable development programs. *Technol. Invest.* 1: 155-172.
- Sinha, R. K., S. Heart, S. Agarwal, R. Asadi, and E. Carretero. 2002. Vermiculture and waste management: study of action of earthworms *Eisenia foetida*, *Eudrilus euginae* and *Parionyx excavatus* on biodegradation of some community wastes in India and Aus-

- tralia. *Environmentalist*, 22: 261-268.
- Suthar, S. 2008a. Development of a novel epigeic-anecic based polyculture vermireactor for efficient treatment of municipal sewage water sludge. *Int. J. Environ. Waste Manage.* 2(1-2): 84-101.
- Suthar, S. 2008b. Metal remediation from partially composted distillery sludge using composting earthworm *Eisenia fetida*. *J. Environ. Monit.* 10: 1099-1106.
- Suthar, S. 2009. Vermicomposting of vegetable-market solid waste using *Eisenia fetida*: impact of bulking material on earthworm growth and decomposition rate. *Ecol. Eng.* 35: 914-920.
- Suthar, S. 2010. Recycling of agro-industrial sludge through vermitechnology. *Ecol. Eng.* 36: 1028-1036.
- Tripathi, G. and P. Bhardwaj. 2004. Comparative studies on biomass production, life cycles and composting efficiency of *Eisenia fetida* (Savigny) and *Lampito mauritii* (Kinberg). *Biores. Technol.* 92: 275-283.
- Wani, K. A. and R. J. Mamta Rao. 2013. Bioconversion of garden waste, kitchen waste and cow dung into value-added products using earthworm *Eisenia fetida*. *Saudi J. Biol. Sci.* 20: 149-154.
- Wiersma, F. and D. S. Benham. 1974. Design criteria for evaporative cooling. ASAE paper (74-4527), Joseph St., MI 49085.
- Yadav, A. and V. K. Garg. 2011. Recycling of organic wastes by employing *Eisenia fetida*. *Bioresour. Technol.* 102: 2874-2880.
- Yadav, K. D., V. Tare, and M. M. Ahammed. 2010. Vermicomposting of source-separated human faeces for nutrient recycling. *Waste Management* 30(1): 50-56. ■■

## EVENT CALENDAR

- ◆ **IMATEX E.A 2015**  
—International Modern Agricultural Technologies Exhibition East Africa 2015—  
*August 6-8, 2015, Nairobi, KENYA*  
[www.inagritech-exhibition.net/why-should-visit](http://www.inagritech-exhibition.net/why-should-visit)
- ◆ **The 3rd INAgriTech 2015**  
—The 3rd Indonesia International Agricultural Equipment, Technology & Machinery Exhibition 2015—  
*August 6-8, 2015, Jakarta, INDONESIA*  
[www.inagritech-exhibition.net/why-should-visit](http://www.inagritech-exhibition.net/why-should-visit)
- ◆ **Construction, Technology and Environment in Farm Animal Husbandry**  
*September 8-10, 2015, Friesing-Weihenstephan, GERMANY*  
<http://www.btu-tagung.de/>
- ◆ **HAICTA 2015**  
—7th International Conference on Information and Communication Technologies in Agriculture, Food and Environment—  
*September 17-20, 2015, Kavala, GREECE*  
<http://2015.haicta.gr/>
- ◆ **The Vietnam Farm Expo 2015**  
*October 1-5, 2015, Ho Chi Minh City, VIETNAM*  
<http://www.vietnamfarmexpo.com/en/>
- ◆ **2nd International Symposium on Agricultural Engineering**  
*October 9-10, 2015, University of Belgrade, SERBIA*  
<http://www.isae.agrif.bg.ac.rs/>
- ◆ **Synergy 2015**  
—Engineering, Agriculture and Green Industry Innovation IV International Conference—  
*October 11-15, 2015, Gödöllő, HUNGARY*  
<http://synergy2015.hu/>
- ◆ **2015 International Agricultural Exhibition**  
*October 15- November 1, 2015, Naju, KOREA*  
<http://www.iae.or.kr>
- ◆ **ISB-INMA TEH' 2015 International Symposium**  
*October 30-November 1, 2015, Roma, ITALY*  
<http://isb.pub.ro/isbinmateh.html>
- ◆ **AgroWorld Kazakhstan**  
—Central Asia's International Agricultural Exhibition—  
*November 4-6, 2015, Almaty, KAZAKHSTAN*  
<http://agroworld.kz/en/>
- ◆ **Land.Technik AgEng 2015**  
*November 6-7, 2015, Hannover, GERMANY*  
[www.vdi.de/landtechnik-ageng](http://www.vdi.de/landtechnik-ageng)
- ◆ **9th CIGR Section VI International Technical Symposium**  
*November 16-20, 2015, Auckland, NEW ZEALAND*  
<http://www.cigrvi.com/>
- ◆ **International Symposium Gembloux 2015**  
*November 25-27, 2015, Gembloux, BELGIUM*  
<http://www.kemiz.up.lublin.pl/index.php?id=konferencje>
- ◆ **44th Actual Tasks on Agricultural Engineering**  
*February 23-26, 2016, Opatija, CROATIA*  
<http://atae.agr.hr/>
- ◆ **4th CIGR International**  
—AgEng Conference 2016—  
*June 26-29, 2016, Aarhus, DENMARK*  
<http://conferences.au.dk/cigr-2016/> ■■



# Development of a Mechanical Family Poultry Feeder



by  
V. I. Umogbai  
Associate Professor of Agricultural &  
Environmental Engineering (Farm, Power & Machinery),  
Department of Agricultural and Environmental  
Engineering, University of Agriculture,  
Makurdi, NIGERIA  
victorimolemhe@yahoo.com

## Abstract

The growing need for poultry products by consumers has urged the necessity for small and medium scale poultry farmers to meet up the demand since they supply the bulk need of the market especially in the developing countries. There exist the need to produce birds that will meet the market standards within the shortest time without straining the farmer's time, resources and energy. This project was undertaken in an effort to provide a labour/time saving mechanically operated automatic feeder that will optimize feeding of birds in family poultry and small/medium scale poultry farms. The density, moisture content, angle of repose and the coefficient of friction between the feeds and the bin material of the feeder were used in the design analysis. The model feeder which could feed twenty five (25) adult poultry birds for one week was constructed using sheet metal, wood, and spring as construction materials. The feeder trough and hopper are of 20 gauge metal sheet. In operation, the trough held 5 kg of feeds thus pulling the stopper to block the hopper for the introduction of the feed. The feeder set up dispensed its content to twenty five (25) adult layers for a period of one week. From the feeder evaluation using Roman Brown layers, the consumption efficiency was 70 % per week. The feeding convenience for the twenty five (25) birds

(layers) of average weight of 1.53 kg was about 80 % with permissible wastage of 30 %. Cost of production is N14,000:00 (\$86:00).

**Key Words:** Design; Construction; Testing; Family; Poultry; Feeder.

## Introduction

Over the last 20 years, due largely to genetic selection but partially to improvements in nutrition, there has been a substantial decrease in the time it takes to grow a broiler to market weight. Much of this improvement is attributed to increased food intake (Mack, *et al*, 2005). The invention of improved mechanical feeding system led to a dramatic reduction in stress due to the elimination of manual feed sorting and relocation of birds by weight, more efficient feeding, less disturbance by staff, the elimination of meal replacement due to better weight control monitoring and increased productivity due to less handling. All of these factors contribute to the realisation of the birds' genetic capabilities. According to Francis (2001), there is also an increased efficiency for the producer as no time is required to correct uneven bird weights and staff will have more time to devote to animal husbandry.

The term "Family Poultry" refers to any genetic stock of poultry (unimproved or improved) raised intensively, semi-intensively or extensively in relatively small num-

bers (Geoffrey, 1973; Day, 1983; Luciano, 2005).

Most of the 826 million people still suffering from malnutrition and approximately 1,200 million people living on less than one US \$ per day are to be found in developing countries, especially in the arid zones of Africa and Asia (UNDP, 2007). Family poultry (FP) represent an appropriate system for supplying the fast growing human population with high quality protein and providing additional income to resource-poor small farmers, especially women, although requiring low levels of inputs (i.e. housings, cages, feeds, breeds, vaccines, drugs, equipment and time/attention). Family poultry contributes significantly to food security and poverty alleviation. Moreover, Family poultry constitute an important component of the agricultural and household economy in the developing world, a contribution that goes beyond direct food production as well as job and income generation for small farmers. (Guèye, 2002)

## Poultry Feeders for Developing Countries

Before the development of the automatic feeder technology, people were used to the conventional method of feeding chickens which is by filling containers with grains and foods manually. The main problem encountered by using this method is, the need to continuously provide the food, be alert and conscious of



the food remaining in cages by the breeders. The sufficient amount of the food provided also cannot be determined clearly. There is much waste and is non-economical. Breeders also find that it is difficult to manage their business effectively because they need to be around the cages every now and then to monitor the poultry. There are various designs of feeding equipment which vary from country to country as stated by Nesheim *et al.* (1979). Irrespective of the method of design, the guiding principles in feeder design is that it must be easy to fill and clean; built to avoid waste; arranged such that fowls cannot roost on them; and constructed with durable materials in such a manner that so long as they contain feed at all, the fowl will be able to reach it with good feeding space (Nesheim *et al.*, 1979).

For about sixty-five years ago, almost all poultry feed was distributed by hand to birds mainly in square bottom troughs, wooden or metal feeders. Later mechanical and automatic feed systems were invented and they help to modify the feeding system, save labour and increase production. Nowadays, the automatic feeding system is available in the market. This method is actually better than manual. But, there are also some problems and weaknesses that need to be overcome and solved. Firstly, the automation, of the computerized method is suitable and caters more to the commercial purpose. Also there is the need for high investment for equipment and devices, and precise manual guide and knowledgeable as well as skilled people to operate the machines. More workspace is needed to put and assemble the automatic system. These are not favourable to the family poultry and small scale poultry operators.

A review of literature, of the rural population in Nigeria reveals that 80 % are small scale farmers. A survey of the livestock industry

in most areas in Nigeria indicates that automatic or mechanical feeding equipment are unavailable and where available they are unreliable due to unsteady power supply or too expensive to maintain (Onyebuchi, 1995; Alabi and Aruna, 2005). As a result of such limiting conditions, sophisticated metering poultry feeders appear increasingly as large scale commercial proposition. The challenges which continually faces the poultry industry, especially in African countries and elsewhere in the developing world is the provision of suitable design and economical houses to provide optimum environment for maximum growth and production with economical use of feed (Patrick, 1989). There is therefore the need for development of an efficient family poultry feeder.

#### **Objectives of the Study**

Family poultry and small/medium scale poultry farming are widely practiced by majority of African poultry farmers. The labour involvement and time demand for these poultry ventures make it arduous for most of the farmers. To ameliorate these problems in majority of the rural communities, improved mechanical feeders are required in order to maximize time and reduce labour (Onyebuchi, 1995). This project attempts at solving the problems of high labour/time demand, feed wastage, and irregular/unsteady power supply for feeders associated with small/medium scale poultry farms and family poultry.

#### **Component Parts and Fabrication of the Model Feeder**

The hopper, inner spring casing, stopper, link tunnel, trough funnel, grille cap, distributor cone, feeder trough and the rod stands are the components of the feeder.

**The hopper:** The hopper is made of 20 gauge sheet metal cut 124 cm by 61.7 cm and bent end to end to form the cylindrical portion of the hopper with diameter 41.2 cm. A

50 cm by 124 cm sheet is cut into a trapezoid which is bent round and welded end to end to form a frustum with 41.2 cm at one end and 21 cm at the other end. This frustum of height 50 cm is welded from the 41.2 cm diameter end to the end of the cylindrical hopper. These two sections (cylindrical and conical) welded together forms the hopper having a cylindrical top with a conical bottom, with a total height of 111.7 cm.

**Inner spring casing:** This component which is made of aluminium panel sheet measured 110 cm by 60 cm which is bent to form a cylinder of diameter 20 cm. The ends are joined by anchoring the edges. Then, 10 cm height from one end is cut at intervals to form prongs with flat end 2 cm wide, having spaces of 5 cm between prongs.

**Stopper:** This is made out of 2 cm thick hard wood. The circular shaped stopper, 25 cm in diameter is cut out of a 30 cm<sup>2</sup> wood. Using construction to determine the centre of the circle, holes are made on the wood. Firstly, four 0.5 cm diameter holes are made 1 cm off the centre at 90° to each other. Then eight 2 cm width holes are created 1 cm from the circumferential end of the stopper with 5 cm space interval between these holes.

**Link tunnel:** This component composed of two parts is also made of aluminium panel sheet. The first part is cylindrical in shape with 21 cm diameter and made from a 30 cm by 63 cm panel sheet joined end to end with the edges hammered together. The second part is a frustum with of 21 cm top diameter and 30 cm bottom diameter made of aluminium panel sheet. This shape is developed by cutting a 90 cm by 20 cm aluminium panel sheet then applying the steps on development of a conical frustum. The two parts are joined together by sliding the cylindrical portion through the frustum part until its end with open flap hooks the end mouth of the frustum.

(Goklap and Bundy, 2010)

**Grille cap:** This is made simply from thin metal wire which is bent to form two circles each of 21 cm and 46 cm diameter respectively. With the aid of a wrapping foil, the thin metal circles are wrapped around the circumference. Then, aluminium panel sheet is cut into several trapezoids (15 in number) of sides 1 cm and 2 cm and height 20 cm. These trapezoids are bent at the 1 cm and 2 cm ends to form a small circular tunnel for the passage of the wrapped circular wires. When these panel plates are fixed to both wires a grille is formed.

**Distributor cone:** This is a 24 cm diameter cone of height 30 cm made of aluminium panel sheet. This is developed from a 72 cm by 30 cm sheet cut in accordance with the conical development rule as contained in. (Goklap and Bundy, 2010)

**Feeder trough:** A 10 cm by 138 cm aluminium sheet metal of 20 gauge is welded at one end with a circular sheet of same material of

diameter 46 cm to form a cylindrical container. Then 3 pieces of 2 cm diameter hollow pipes of height 15 cm are welded to the side of the container so as to form a tripod. Holes are then bored centrally on these pipes and a 2-inch nut welded to each pipe about the holes to allow the passage of the screw measuring 5 cm in length welded to a 2 cm diameter circular end which serves as a knob used for tightening or loosening.

**Rod stands:** These are made from stainless steel rods of height 20 cm. They are three in number. They fit into the hollow pipes and are then screwed tight to make the stands hold firm in position. Other materials used in the feeder construction include; wire and spring and mild U-metal screw.

**Wire and spring:** The wire and spring is the main mechanism that controls, regulate and co-ordinate the metering of the feeds from the hopper to the feed trough. The arrangement is such that the wire

runs from the ceiling hoist to about 75.5 cm into the hopper from where it hooks up the spring at one end. The other end hooks up the U-rod embedded in the stopper from where another wire continues from the opposite end of the stopper to the feeder trough, where it is attached to a U-rod at the base. The spring possesses the necessary elastic strength, to suspend the stopper plate as it is pulled downwards by the weight of feed in the trough to block further discharge of feeds. When the feed quantity in the trough reduces to a certain level, it causes decrease in weight which in turn makes for a pull of the spring. This pulling leads to the raising of the stopper of the hopper which allows for an opening for the discharge of feed once more to the trough.

**Mild U-metal screw:** The U-shaped metal has both ends threaded to allow for bolting. This U-rod has the main function of holding the spring mechanism to the trough. Bolts are used to hold the two ends

Fig 1 Pictorial drawing of the developed feeder

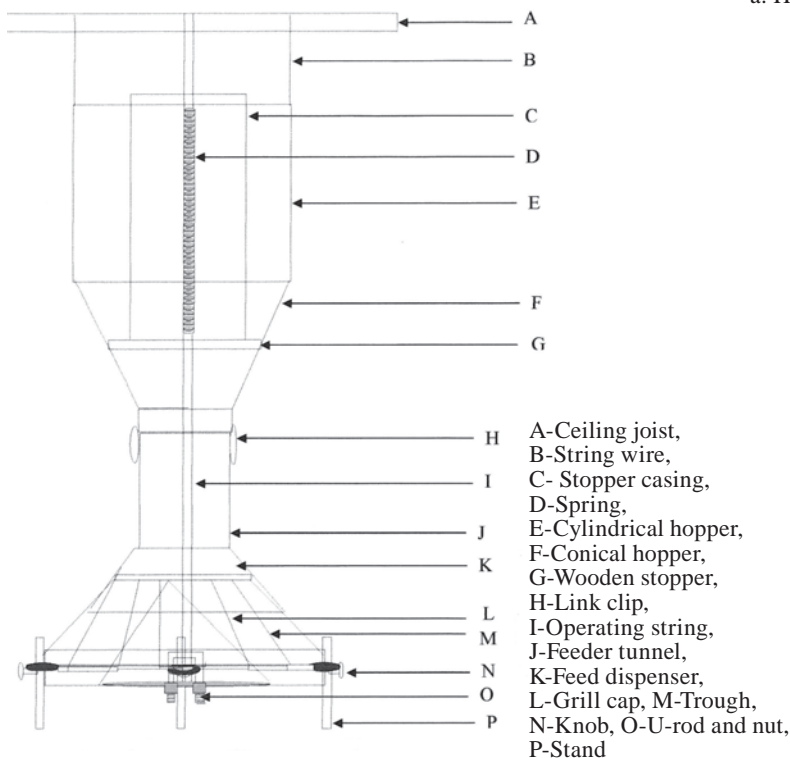
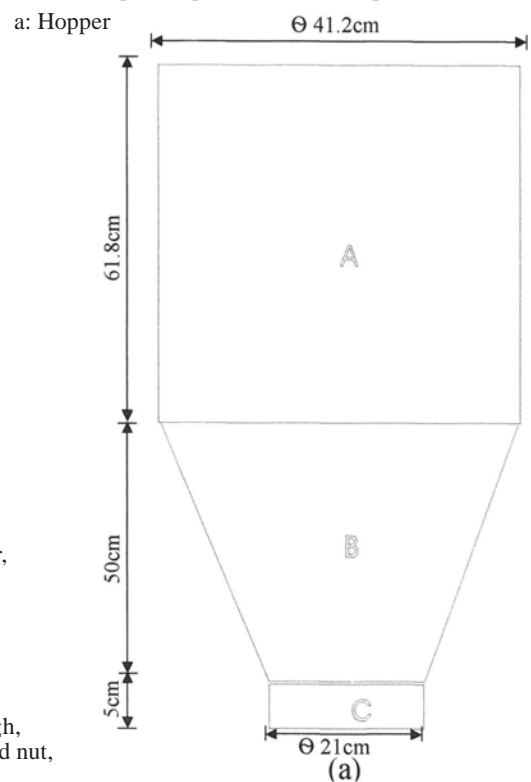


Fig. 2 Component parts of the developed feeder



of the rod as it pass through the holes made on either the stopper or the base of the trough. With the aid of washers, the rods are held steady to the feeder mechanism.

A pictorial drawing of the developed feeder is shown in Fig. 1. Fig. 2 is the component parts of the feeder with dimensions. A photograph of the feeder during evaluation is shown in Fig. 3.

## Materials and Methods

Commercial feeds for poultry birds in Nigeria were used for design analysis and evaluation of the mechanical family poultry feeder. They are the layer marsh, growers marsh, broiler finisher and broiler starter. The physical properties of the feeds determined were sizes, density, angle of repose/coefficient of friction and moisture content.

### Size of Feeds

Sizes of feeds were obtained

from the hand book of the producing company, Grand Cereals Ltd. A subsidiary of UAC Nig. Plc., Jos, Plateau State, Nigeria. They were further confirmed by sieve analysis using a set of BS 41 sieves.

### Density of Feeds

The density of feeds for the five samples of poultry feeds were determined experimentally and calculated using the formula:

$$\rho = M/V \dots\dots\dots (1)$$

Where:

$\rho$  = density of feed

M = mass of feed

V = volume of feed

### Angle of Friction

To design the hopper the angle of incline should be such that a free flow of feed is guaranteed or enhanced. The angle of friction was determined by pouring 5 kg of feed on a 1.5 mm thick mild steel sheet on the angle of friction device developed by Umogbai (2009). Ten trials were carried out and the mean

determined as follows:

$$\theta = \sum\theta/N \dots\dots\dots (2)$$

Where:

$\theta$  = angle of friction

N = number of measurements

$\sum\theta$  = sum total of measured angles

### Moisture Content of the Feeds

The oven drying method at a temperature of 105 °C for 24 hours was used to determine the moisture content of the feeds and computed as follows:

$$mc = [(mi - mf) / mf] \times 100 \dots\dots (3)$$

Where:

mc = moisture content of feed sample

mi = mass of wet feed sample (ordinary state of the feed)

mf = mass of dried feed sample

### Feed Metering Spring/Hopper/Trough

The spring mechanism shown in Figs. 1 and 2 controls, regulates and co-ordinates the metering of the feed from the hopper to the feed trough. The performance and ef-

Fig. 2 Component parts of the developed feeder

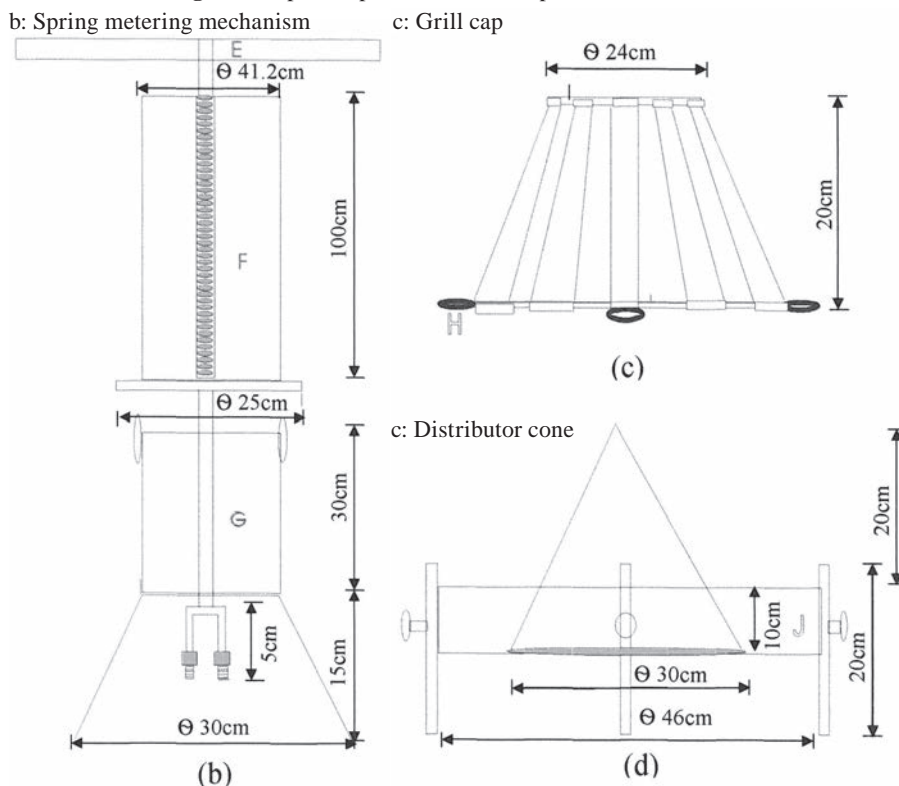


Fig. 3 Photograph of the developed feeder during evaluation



iciency of the spring was assessed using Hooke's law of elasticity (Wikipedia, 2010). The elasticity and maximum strength of the steel spring was determined in the civil engineering laboratory, University of Agriculture, Makurdi.

The original length of the unstretched spring was measured using a meter rule. Weights of 1 kg, 2 kg, 3 kg, 4 kg and 5 kg were separately used to determine the springs tensile strength and the extensions were recorded.

**Assumptions Made for the Design are:**

That each bird can consume 0.9 kg of feeds per week amounting to 0.13 kg per day. (Williamson and Payne, 1978)

- That the bin is to be put to effective use for at least 5 years.
- The longest time a farmer can be away is one week.
- The hopper could contain one bag of poultry feed which is 25 kg.
- The feed trough could carry a maximum load of 5 kg at a time. This value is based on the maximum stress capacity of the spring.

Articles and formulae from the following sources were used in the design computations and analysis: Smetana (1996); Williamson and Payne (1978); Hughes (1970); <http://www.alibaba.com/poultryfeeding-system> (2010); Automatic Livestock feeders/ [www.poultryco.org](http://www.poultryco.org); Chang *et al.* (1984); Chang and Converse (1988); Chang, *et al.* (1990); Goklap and Bundy (2010); [www.wikipedia.org](http://www.wikipedia.org) (2010); Molenda *et al.* (2009); MWPS, 1983; Oberg *et al.* (2004); Ojah and Michael (1999); Khurmi and Gupta (2005); and Tim and Roberts (2009).

The calculated parameters and their results are shown on **Table 1**.

To calculate the number of birds to feed on the feed trough; from the linear feeding space of poultry birds at 6 weeks is 5.8 cm (which is also the length of the grille cap). (Oluyemi and Roberts, 1979)

Thus to get the linear length of

the trough Lt;

$$Lt = \pi D \text{ (Formula for perimeter of a circle) } \dots\dots\dots(4)$$

$$= 3.14 \times 46 = 144.53 \text{ cm}$$

It therefore follows that for a trough of 144.532 cm, the total number of birds it can accommodate during feeding is calculated thus;

$$\begin{aligned} \text{Number of birds} &= (\text{length of trough})/(\text{Linear feeding space}) \dots\dots\dots(5) \\ &= 144.532 / 5.85 \\ &= 24.92 \approx 25 \text{ birds} \end{aligned}$$

Therefore total number of birds the feeder can accommodate is 25 birds.

$$\begin{aligned} \text{1 bird per day:} &130 \text{ gm of feed (Williamson and Payne, 1987).} \\ \text{25 birds per day:} &130 \text{ gm feed} \times 25 \text{ birds per day} / 1 \text{ bird per day} = 3250 \text{ gm feed per day} = 3.25 \text{ kg of feed per day} \end{aligned}$$

$$\begin{aligned} \text{25kg of feed will sustain 25 birds for:} &= (1 \text{ day} \times 25 \text{ kg}) / 3.25 \text{ kg} \dots\dots\dots(6) \\ &= 7.69 \text{ days (1 week adopted)} \end{aligned}$$

From the calculations above, it therefore means that, 25 birds will consume 25 kg (one bag of commercial poultry feed) of feed for one week.

**Performance Evaluation**

Testing was carried out on the feeder to ascertain its functionality and determine the efficiency of the feeder. Twenty-five (25) Roman brown birds (layers) were used for evaluation at the poultry unit of the University of Agriculture, Makurdi research farm. The evaluation was monitored for duration of three weeks. The performance of the developed feeder was compared with the pan feeder which is the popular feeder used by poultry farmers in Nigeria. The pan feeder is also the

**Table 1** Design parameters and their results

Parameter	Result
Actual capacity of bin and hopper	0.27 m <sup>3</sup>
Feed pressure on the feeder wall	353.1 N/m <sup>2</sup>
Dynamic lateral pressure	391.1 N/m <sup>2</sup>
Horizontal force acting per unit length	745.91 N
Circumferential stresses on hopper	331.2 KN/m <sup>2</sup>
Longitudinal stresses	1.66 KN
Shear stresses for the trough	316.6 N/m <sup>2</sup>
Thickness of metal sheet for construction	0.58 mm
Load on trough stand	56.9 N
Shear stresses on Spring	483.9 N/m <sup>2</sup>
Axial deflection of spring	0.3 mm
Stiffness of the spring (spring rate)	0.21 N/m
Spring diameter	3.9 mm

type used in the University of Agriculture, Makurdi poultry research farm. Factors considered in the evaluation were feed consumption, number of eggs produced per day, weight-change per bird, feeding convenience, feed wastage, and feeding efficiency.

**Determination of Feed Consumed**

Blanco and Groom's formula was used for the evaluation.

$$M_c = M_s1 - (M_s2 + M_s3) \dots\dots\dots(7)$$

(Blanco and Groom, 2006)

Where:

$M_c$  = mass of feed consumed by birds during one week (kg)

$M_s1$  = the mass of feed introduced into the feeder trough and hopper (kg)

$M_s2$  = mass of feed in both hopper and trough at the end of one week (kg)

$M_s3$  = mass of feed wasted to the floor in one week (kg)

**Number of Eggs Produced**

This was done by counting the number of eggs produced by the birds per day.

**Weight Change**

A digital weighing balance was used to measure the weight change per bird after one week feeding.

**Feeding Convenience**

Convenience is a function of the number of birds that will be per-



mitted continuous feeding to the number that will have to wonder a while before they have opportunity to feed. This occurs at any time (t) when the 25 birds used try to feed from the feeder at the same time. For the first day, it occurred at about 3 hours into the evaluation process. The whole birds tried to feed from the feeder trough but 6 birds could not find comfortable space around the feeder. They wonder off until a space was created by voluntary withdrawal of the birds already feeding. This situation repeated itself at different times at different days of the week with the feeding convenience calculated using Johnston and Cianmiel's equation.

$$F_c = \sum_i^N [(NT - Nt) \div NT] \times 100 / N \dots \dots \dots (8)$$

(Johnston and Ganmiel, 2006)

Where:

$F_c$  = Feeding convenience for the birds for one week

$N$  = 7 days involved

$N_t$  = Number of birds wondering around for space at maximum feeding in a day

$N_T$  = Total birds sample = 25

### Feed Wastage from the Trough

For the duration of experimentation, the poultry pen where this evaluation is set up was swept twice daily, so that the amount of feed wasted to the floor was collected and weighed to determine the mass of wastage.

$$W_t = \sum_j^N W_n \dots \dots \dots (9)$$

(Johnston and Ganmiel, 2006)

Where:

$W_t$  = wastage from the trough per week

$N$  = 7 days involved

$W_n$  = mass of waste to the floor collected per day.

### Efficiency of the Feeder

This involves the application of the values derived above as presented in Guèye's efficiency formula (E);

$$E = (\text{mass of feed consumed by birds} - \text{mass of wastage} / \text{mass of anticipated consumption}) \times 100 \dots \dots \dots (10)$$

(Guèye, 2002)

### Operation of the Feeder

The main parts of the feeder of are the hopper (upper portion), the link tunnel (mid section) and the trough (lower portion). These three parts are easy to detach and couple for ease of handling, cleaning and transportation. The steel spring is the main mechanism that regulate and co-ordinate the metering of the feeds from the hopper to the feed trough. The spring possess the elastic strength to suspend the plate that is pulled downwards by the weight of feed in the trough to block excess discharge of feed. When the quantity of feed in the trough reduces, the decrease in weight causes a pull of the spring which then opens the mouth of the hopper for release of feeds to the trough.

About 5 kg of feed is initially fed into the trough so that on hanging it pulls the stopper to close the hopper via the string wire hanging mechanism. Then, 20 kg (one bag) of the feed is discharged into the hopper.

## Results

**Table 2** shows the physical properties of feeds used for the construction of the feeder and performance evaluation. **Table 3** is the laboratory test for steel spring elasticity used for metering the feeds. **Table 4** is the evaluation of the feeder for a duration of three weeks, while **Table 5** gives the performance and operating parameters between the developed feeder and the pan feeder.

## Discussion

Five types of feeds were used to determine the physical properties of the available feeds. From **Table 2**, it is observed that the growers mash, the layers mash and the broilers finisher have the largest sizes of 6 mm, 6 mm and 5 mm respectively. The sizes of the broiler starter and chick mash were 3 mm. The angle of repose did not vary significantly as the angle ranged from 43° to 46.8°. The moisture content was highest 17.46 % for the growers mash and lowest 14.24 % for the broiler starter. The coefficient of friction ranged from 0.62 to 0.8. There was however a noticeable variation in density of the feeds, with the broiler finisher having the highest density of 635.54 kg/m<sup>3</sup>. This was closely followed by the broiler starter with a density of 629.61 kg/m<sup>3</sup>. The chick mash, the layer mash and the growers' mash have densities of 598.00 kg/m<sup>3</sup>, 595.00 kg/m<sup>3</sup> and 485.15 kg/m<sup>3</sup> respectively.

The laboratory test (five readings)

**Table 2** Physical properties of feeds used for construction and performance evaluation

Feed type (trade name)	Available size, mm	Angle of repose, $\phi$	Moisture content, %	Coefficient of friction, $\mu$	Friction	Density kg/m <sup>3</sup> , $\sigma$
Growers mash	6	46.6	17.46	0.62	32	485.15
Broiler starter	3	43.0	14.24	0.62	31.6	629.61
Chick mash	3	46.8	16.9	0.71	35.2	598.00
Broiler finisher	5	44.4	16.80	0.80	38.3	635.54
Layers mash	6	52.1	15.82	0.72	35.7	595.00



for steel spring elasticity almost shows direct proportion to the load applied (**Table 3**). The observed readings fully agreed with Hooke's law of elasticity.

The performance evaluation test for a period of three weeks (**Table 4**) shows that 16.51 kg, 17.66 kg and 18.22 kg of feed were consumed during the first, second and third weeks respectively. This shows a gradual increase in the amount of feed consumed per week. There is also a noticeable decline in feed wastage; 8.49 kg, 7.34 kg and 6.78 kg for first, second and third week respectively. Consumption efficiency increased from the first week through the second to the third week. The most likely reason for the recorded results is that probably the birds were getting more familiar with the developed feeder with increased usage. It was initially observed by the researcher and by other workers in the research farm that the birds were reluctant to feed from the developed feeder during the first few days.

**Table 5** shows comparative performance and operating parameters between the developed feeder and

the pan feeder. More feed was consumed per week when the developed feeder was used; 21.27 kg for the developed feeder and 17.46 kg for the pan feeder. This led to a higher number of eggs (19 eggs) produced per day for the developed feeder as against (17 eggs) per day for the pan feeder. Birds feeding from the developed feeder had an increase in weight of 0.23 kg per bird after feeding for one week while those feeding from the pan feeder gained 0.349 kg per bird. The relatively lower weight gained may be due the higher number of egg produced per day. The more the eggs produced, the more the time spent out of the feeding trough. However, the developed feeder has a higher feeder convenience of 79.7 % per bird per week as against 72.4 % for the pan feeder. Feed wastage per feeder per week is more (7.54 kg) for the pan feeder as compared to 3.77 kg for the developed feeder. The feeding efficiency was higher for the developed feeder. The developed feeder had 85 % efficiency while the pan feeder had 70 %. The feeder was produced at a cost of N 14,000:00; (\$ 86:00).

## Conclusion

A mechanical poultry feeder has been designed, constructed and tested. The evaluation of feeder was carried out with roman brown layers (laying poultry birds) with an average weight of 1.43 kg per bird. Results under a period of three weeks showed an average feeding efficiency of 85 % per week. The feeding convenience for the 25 birds used as sample was 79.7 % on the average permitting wastage of about 30 %. These results are indicators of the fact that the feeder can be improved upon with adjustment of some of the defects such as feed blockage by the wooden stopper in the hopper and the grill cap alignment which encourage the wastage of feed discharged from the hopper into the feed through.

## Acknowledgement

I sincerely appreciate the contributions of Alivionote Itarakhe and Kondum Franklin both of the Department of Agricultural and Environmental Engineering, University of Agriculture, Makurdi in data collection. I also thank the staff of the

**Table 3** Laboratory test for steel spring elasticity

Mass, KG	Length of un-stretched spring, cm	Length of stretched spring, cm
1	24.5	25.2
2	24.5	27.0
3	24.5	29.5
4	24.6	32.1
5	24.8	34.7

**Table 4** Evaluation of the feeder

Test Factor	Week 1	Week 2	Week 3	Standard Error
Feed Consumed per week, Kg	16.51	17.66	18.22	± 0.41
Feed Wastage, Kg	8.49	7.34	6.78	± 0.37
Consumption Efficiency, %	66	71	73	± 1.70

**Table 5** Comparison of performance and operating parameters between the developed feeder and the pan feeder using roman brown layers

Factors Considered	Developed feeder	Pan feeder	Remark, s
Feed Consumed per week	21.23 kg	17.46 kg	+ 3.76 kg feed consumed on developed feeder trough
Eggs Produced per day	19	17	+ 2 Eggs produced using developed feeder
Weight change per bird after one week Feeding	+ 0.23 kg	+ 0.35	- 0.12 kg due to more eggs by the developed feeder produce better layers
Feeding Convenience per bird per week	79.7 %	72.4 %	+ 7.3 % convenience using developed feeder
Feed Wastage per week	3.77 kg	7.53 kg	+ 3.76 kg wastage on developed feeder
Feeding Efficiency	85 %	70 %	Pan feeder has + 15 % feeding efficiency
Labour requirement per 200 birds	1 man	3 men	Developed feeder saves cost of labour by 66.7 %

University of Agriculture, Makurdi Poultry Farm.

## REFERENCES

- Alabi, R. A. and M. B. Aruna. 2005. Technical efficiency of family poultry in Niger-Delta, Nigeria. *Journal of Central European Agriculture*, 6(4): 5531-538.
- Automatic livestock feeders / [www.poultrycoop.org](http://www.poultrycoop.org)
- Blanco, J. A. and B. M. Grook. 2006. Simulation models for feeding broilers. *Nutritional modelling in pig and poultry production* (eds. Moon J. K. and M. K. Titus), pp. 188-208. Wallingford, U.K.
- Chang, C. S., H. H. Converse, and F. S. Lai. 1984. Flow rates of wheel and sorghum through horizontal and vertical orifices. *Transactions of ASAE*, 31(1): 300-304.
- Chang, C. S. and H. H. Converse. 1988. Flow rate of corn through orifices as affected by moisture content. *Transactions of ASAE*, 27(5): 1586-1589.
- Chang, C. S., H. H. Converse, and J. H. L. Steele. 1990. Flow rate of grains through vertical orifices. *Transactions of ASAE*, 33(2): 601-606.
- Day, E. J. 1983. Trends in Layer Feed Formulation. *Poultry Digest* (July 328-334).
- Francis, H. 2001. *Economic Analysis of Poultry Farming*. First edition. Horwood press Co. Canada.
- Geoffrey, E. 1973. *Home Poultry Keeping*. EP Publishers, Vienna, Austria.
- Gokalp, Z. and D. Bundy. 2010. Analysis of lateral design pressures, vertical frictional forces and bending stresses on horizontally corrugated steel silo wall panels. *Transactions of ASABE*, 28(2): 71-79.
- Guèye, E. F. 2002. *Family Poultry Research and Development in Low-income Food-Deficit Countries: Approaches and Prospects*. *Outlook on Agriculture* 31: 13-21.
- Hughes, B. O. 1970. Feeding behaviour in domestic fowl. N.A.A.S Open conference, Edinburgh, UK. [http://www.alibaba.com/poultry feeding system](http://www.alibaba.com/poultry_feeding_system). 14/06/2010.
- Johnston, A. T. and R. M. Ganmiel. 2006. Egg production in laying hens. In *Mechanistic modelling in pig and poultry production* (eds. FM Green, and K Tier), pp. 289-299., BSAP, Edinburgh.
- Khurmi, R. S. and J. K. Gupta. 2005. *A textbook of machine design*. Eurasia Publishing House (PVT) LTD. New Delhi.
- Luciano, G. 2005. *Farm Animal Health and Feed Needs*. Schering-Plough Animal Health, Italy. *World Poultry* vol 21. No.12, 133 - 139.
- Mack, S., D. Hoffman, and J. Otte. 2005. The Contribution of Poultry to Rural Development. *World Poultry Science*, 61: 7-14.
- Molenda, M., M. Montross, S. A. Thompson, and J. Horabik. 2009. Asymmetry model of bin wall loads and lateral pressures induced from two and three-dimensional obstructions attached to the wall. *Transactions of ASABE*, 52(1): 225-233.
- MWPS. 1983. *Grain bin loads and pressure, structures and environment Handbook* 11th Ed.
- Nesheim, N. C., R. E. Austic, and L. E. Card. 1979. *Poultry Production*. 12th Edition. Coll. Mag. Press Co. Hutchinson, London.
- Oberg, A., F. Ron, and F. Sue. 2004. *Machinery's Handbook*. Industrial press; New York.
- Ohja, T. P. and A. M. Michael. 1999. *Principles of Agricultural engineering* (vol. I & II). Jain brothers, New Delhi.
- Oluyemi J. A. and F. A. Robert. 1979. *Poultry Production in Warm Wet Climate*. Pub. Macmillan national. College Ed. Ibadan.
- Onyebuchi J. C. 1995. *Design and Development of a Self Metering Poultry Feeder*. A project presented to the Department of Agricultural Engineering. University of Agriculture, Makurdi. (Unpublished).
- Patrick, T. B. 1989. Poultry Housing Designs for Tropical Environment and use. *Poultry Science*, July 1989 Vol. 68, No.7, pg 13.
- Smetana, P. 1966 *Poultry production in Burma*. FAO/FFHC poultry training course, Vet. College, In-sien, Burma.
- Tim, F. and A. W. Roberts. 2009. Basic principles of bulk solids storage, flow and handling. The institute of bulk materials handling research, Utah.
- Umogbai, V. I. 2009. Development of an Angle of Friction Measuring Device. *Journal of Engineering Science and Technology* 4(1): 116 -121.
- UNDP. 2007. *Fighting Climate Change: Human Solidarity in a Divided World: Human Development Report* (UNDP), New York, U.S.A.
- Wikipedia 2010/Typical tensile strength of metals.
- Williamson, G. and W. J. A. Payne. 1978. *An Introduction to Animal Husbandry in the Tropics* (Third Edition). Longman, U.K. pp755.

■ ■

# Performance Evaluation Analyses of Commercial Sugarcane Mechanical Harvesting Contractor Operations

by  
C. N. Bezuidenhout  
Associate Professor & SASRI Research Fellow,  
School of Engineering, University of KwaZulu-Natal,  
Private Bag x01, Scottsville, 3209,  
SOUTH AFRICA

P. Langlois  
Information Systems Manager,  
Compagnie D' exploitation Agricole Ltée,  
Grand River North West, P.O. Box 242,  
Port Louis,  
MAURITIUS

## Abstract

Mechanical sugarcane harvester research has included studies about cutting efficiency, cost analyses, design and impacts on cane crop production and quality. The nature and scale of commercial operations introduce new problems for a commercial contractor to remain profitable and sustainable. Often data concerning contractor operations are captured, but these records are seldom analysed. The aim of this research was to demonstrate research approaches to explore the performance of large scale commercial mechanical sugarcane harvesting operations. A negative correlation was found between diesel consumption and harvesting rate. A logarithmic relationship existed between idle time and machine performance, and blade maintenance enhanced machine performance.

**Keywords** Performance indicator, correlation graph, chopper harvester, sugarcane, efficiency, TDH Index

## Introduction

Similar to other agricultural mechanization equipment, mechanical sugarcane harvesters, also known as chopper harvesters, have received significant research attention. This includes, among others, studies on cutting efficiency (de Beer and Boevy, 1977), cost analyses (Salassi *et al.*, 2002), selection of appropriate designs and configurations (e.g. Braunbeck *et al.*, 1999; Li *et al.*, 2002) and impacts on crop production and cane quality (Viator *et al.*, 2007). At a typical commercial sugarcane farming scale, chopper harvesters are relatively expensive and harvesting capacity often exceeds the demand of a single farm. Hence, worldwide, chopper harvesters are often operated by commercial contractors who would typically service a number of sugarcane producers.

Although the field-scale scientific research cited above is valuable, the nature and scale of commercial operations introduce new economic and operational challenges. Different clients, sugarcane fields, sugar mills and operating environments introduce a range of issues that have

to be managed on a day to day basis in order for the commercial contractor to remain profitable and sustainable. These include, among others, prioritizing more important clients, matching the correct equipment with the correct operating environments, dealing with political and social issues, and managing contracts, equipment transfers, diesel supply, maintenance, breakdowns and blade replacements. Some of these scenarios have been described and investigated by various researchers, such as Higgins *et al.* (2004), Le Gal *et al.* (2009) and Stray *et al.* (2012). In many cases the occurrence of problems and opportunities are one-off, but over time it becomes necessary to detect good decisions from the past and to learn from previous mistakes.

For accounting purposes harvesting contractors normally capture and retain a fair amount of data concerning their operations. These may include descriptions of workloads, maintenance records, operator performance for bonus purposes, blade replacements and diesel consumption records. However, these records are often disconnected. For example, diesel records may be

maintained to ensure that a supplier is correctly reimbursed and that fuel theft can be detected, while harvesting records may be kept on a different system in order to invoice the client.

Often medium to large scale harvesting contractors do not possess the time, statistical skills and appropriate data structures and expertise to draw value from the wealth of data that may be stored. Although some companies may generate graphs and summary tables of performance, there is an opportunity to explore captured data more scientifically in order to reveal deeper

trends and patterns. The science and applications of data mining are vast, but tend to gravitate towards analyses in the IT, business and industrial production sectors. Kivijärvi and Tuominen (1996), Hsu (2009), Köksal *et al.* (2011), Çiflikli and Kahya-Özyirmidokuz (2010) and Domínguez (2012) describe such research in a wide range of mainly manufacturing industries and demonstrate how industry can draw value from advanced data analyses approaches.

The aim of this research was to demonstrate research approaches to explore patterns and general

performance trends in large scale commercial mechanical sugarcane harvesting operations. Specific objectives included the preparation of data into suitable formats, demonstrating multivariate analyses approaches, evaluating performance indicators and providing the contractor with recommendations based on these outcomes.

## Methodology

### Background and Data Preparation

The Compagnie D'exploitation Agricole Ltée (CEAL) operates a fleet of approximately ten chopper harvesters in Mauritius. Harvesters are deployed between different sugar milling areas across the island and clients range from large estates with dedicated machines to small growers who may require harvesting for one or two days only. **Table 1** depicts the harvesters that were in operation during the 2011 and 2012 milling seasons.

A total of 2,740 daily data records for the 2011 and 2012 harvesting seasons were collated. The data included a range of descriptive variables as listed in **Table 2**. For each day the client and site where the machine operated was captured and the number of tractor trailers that moved billeted cane out of the field was recorded. It was also recorded whether tractor trailers offloaded into bins or whether these units moved the cane directly to a nearby sugar mill. The quantity in tons of cane harvested were captured at the mill's weighbridge. Machines sometimes worked on more than one task, such as different clients, on a particular day. Therefore, the total tons harvested by the machine for the

**Table 1** Mechanical sugarcane harvesters operated by the CEAL group between 2011 and 2012

Machine type & ID	Capacity (t.hr <sup>-1</sup> )	Days in operation in 2011 - 2012	Average cost per ton of cane (US\$.t <sup>-1</sup> )	Equipment age (years)
CHOPPER 2500/4	42	192	\$4.90	14
CHOPPER 2500/5	31	223	\$5.83	11
CHOPPER 2500/6	46	245	\$4.28	11
Cameco 3500/1	48	281	\$3.70	9
Cameco 3500/2	50	239	\$5.66	8
John Deer 3520/1	59	292	\$2.77	> 11
John Deer 3520/2	58	287	\$3.17	2
Austoff 7700/2	53	286	\$3.09	10
Austoff 7700/3	46	231	\$5.93	10
Austoff 7700/4	52	300	\$5.34	4

**Table 2** Descriptive variables in a mechanical harvesting system, summarized by their mean ( $\bar{x}$ ) and standard deviation ( $\sigma$ ) under different groupings. Values in brackets depict the number of items in each group

Descriptive Variable	Grouping Variable			
	Equipment (10 machines)	Months (7 months)	Sites (50 clients)	Percentile (10 intervals)
Bad weather stops (hr.d <sup>-1</sup> )		$\bar{x}$	$\bar{x}$	$\bar{x}$
Blade replacement frequency (days)	$\bar{x}$	$\bar{x}$	$\bar{x}$	$\bar{x}$
Breakdown frequency (days)	$\bar{x}$			
$\bar{x}$ Daily breakdown time (hr.d <sup>-1</sup> )	$\bar{x}, \sigma$	$\bar{x}$	$\bar{x}$	$\bar{x}$
Daily maintenance time (hr.d <sup>-1</sup> )	$\bar{x}$	$\bar{x}$	$\bar{x}$	$\bar{x}$
Diesel consumption (l.t <sup>-1</sup> )	$\bar{x}, \sigma$	$\bar{x}, \sigma$	$\bar{x}, \sigma$	$\bar{x}, \sigma$
Hours per day harvesting (hr.d <sup>-1</sup> )	$\bar{x}, \sigma$	$\bar{x}$		$\bar{x}$
Idle for refueling (hr.d <sup>-1</sup> )			$\bar{x}$	$\bar{x}$
No work idle (hr.d <sup>-1</sup> )		$\bar{x}$	$\bar{x}$	$\bar{x}$
Performance percentile		$\bar{x}$	$\bar{x}$	
Stop because of milling issues (hr.d <sup>-1</sup> )		$\bar{x}$	$\bar{x}$	$\bar{x}$
Tons harvested per hour (t.hr <sup>-1</sup> )	$\bar{x}, \sigma$	$\bar{x}, \sigma$	$\bar{x}, \sigma$	$\bar{x}, \sigma$
Tons harvested per task per day (t)	$\bar{x}, \sigma$	$\bar{x}$	$\bar{x}$	$\bar{x}$
Total idle time (hr.d <sup>-1</sup> )		$\bar{x}, \sigma$	$\bar{x}, \sigma$	$\bar{x}, \sigma$
Waiting for tractor-trailers (hr.d <sup>-1</sup> )		$\bar{x}$	$\bar{x}$	$\bar{x}$

$\bar{x}$ : data mean;  $\sigma$ : data standard deviation

day (over different tasks) and the tons harvested in an individual task were both recorded. Working hours were recorded by the operator and were billed against a specific task. Based on this, the machine's work rate ( $t.hr^{-1}$ ) could be calculated for individual tasks and for the full day's work. Diesel records were kept by the garage managers and included the date, the amount of diesel issued and the hour meter reading on the machine at the time of refueling. Refueling occurred at any time of the day and sometimes more than once on a day. These records were used to estimate the amount of diesel that was consumed on any particular day. Although there is room for error, a diesel consumption figure (in litres per ton cane) was estimated for each day. A number of different types of idle times were also recorded by the operators. This includes waiting for in-field tractor trailer units to return, idling because the mill experienced problems, bad weather, planned maintenance, breakdowns, refueling and blade maintenance and replacements.

### Data Analyses

For each machine, the total tons harvested per day were sorted from the lowest to the highest. Each day was then allocated a unique percen-

tile value, where 100.0 depicts the day with the highest daily harvesting rate, and 0.0 depicts the day with the poorest harvesting rate. This became another variable in the database and was termed the performance percentile.

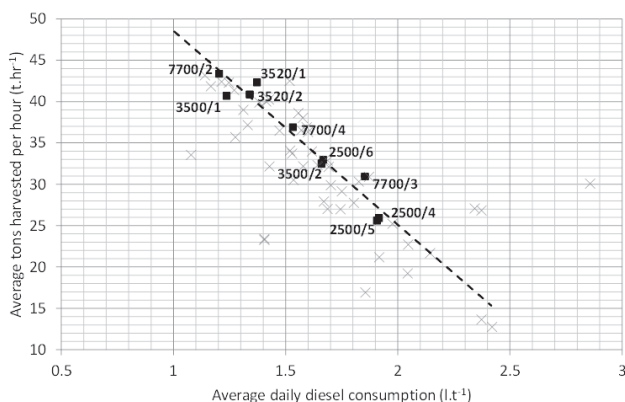
Data were grouped by equipment, month of the year, site and percentile interval (viz. 0-10, 10-20, ... 90-100). In each case the average ( $\bar{x}$ ) –and sometimes the standard deviation ( $\sigma$ ) of a set of descriptive variables were calculated. **Table 2** summarizes the variables that were included in these analyses. In some cases certain variables were excluded, e.g. average frequency of bad weather stops for different equipment. These exclusions were made carefully after the data were investigated and for relatively obvious reasons there were no statistical dependency between variables.

Correlation analysis was conducted for each set of results derived from **Table 2**. For example, in the case of equipment, the performance of the ten harvesters (**Table 1**) were summarized by the 13 descriptive variable aggregates shown in **Table 2** (2nd column) to form a  $10 \times 13$  matrix. This was followed by calculating a Pearson correlation matrix between different variables. These matrixes were studied for patterns

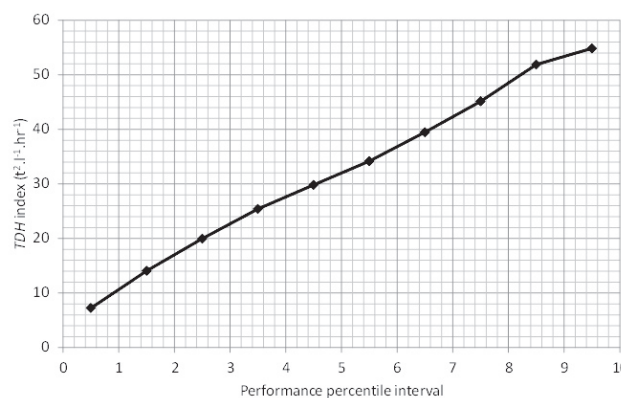
and strong trends, which initiated further investigations. These investigations were explorative and only evaluations that yielded interesting results were included as results in this paper.

For the equipment and sites groups (in **Table 2**) the mean and standard deviations of descriptive variables were normalized and the two matrixes were transposed. As per Samkange and Bezuidenhout (2013), this allows for the calculation of correlation coefficients between sites and between equipment. For example, once the data has been normalized, the  $10 \times 13$  equipment matrix was transposed and the resultant  $10 \times 10$  Pearson correlation matrix now reflects to what extent different equipment experienced similar conditions in terms of the 13 variables that describe the associated operations. These results were projected in a correlation graph (Onnella *et al.*, 2004; Gorban *et al.*, 2010; Samkange and Bezuidenhout, 2013) where each vertex (node) in the network depicts a specific harvester and each edge (line) between vertexes depicts the strength of the correlation coefficient between the two respective harvesters. Energized correlation graphs, where each variable is mathematically positioned in close proximity to other variables

**Fig. 1** Average daily diesel consumption plotted against average daily tons per hour harvested for different machines (labeled black boxes) and for different harvesting sites (unlabeled crosses)



**Fig. 2** An index derived from harvesting rate and diesel consumption (TDH index) plotted against a mechanical harvester's ranking in overall harvesting performance (percentile intervals)





that tend to have similar responses within the system, are valuable in helping to reduce data redundancy and to help focus the investigation. An example of a correlation graph is presented in **Fig. 6**.

A similar correlation graph approach was followed for different sites. Because of the large number of sites, viz. 50, and the subsequent 1,225 correlation coefficients between different sites, a maximal spanning tree algorithm (Heimo *et al.*, 2009) was carried out to reduce redundancy. The maximal spanning tree algorithm retains a single network, but will remove as many edges as possible, while retaining the strongest combination of correlation coefficients. It falls outside the scope of this paper to explain the correlation graphing methodology in more detail and readers are referred to Samkange and Bezuidenhout (2013) for more information.

## Results

One of the most prominent correlation trends between variables was a significant negative correlation between diesel consumption per ton of cane and harvesting rate (**Fig. 1**). This trend was apparent in the raw data and in all the summary tables

(**Table 1**) across equipment, operating sites and times of the year. The trend arises from several underlying operating factors that influence efficiency, including cane yield and field layout. Ideally an operation should be in the top left corner of **Fig. 1** with low diesel consumption and high harvest rates. Bearing this in mind, the performance parameter in **Eqn. 1** was derived and emerged as a robust measure of overall harvesting efficiency throughout the system (**Fig. 2**). In this paper a variable or index is considered robust if it is (a) not ambiguous, (b) sensitive to performance, and (c) difficult to manipulate artificially. This parameter was termed the TDH index (T for tons, D for diesel, H hours) and, because of its robustness and difficulty to purposefully manipulate, the index creates an opportunity for management to implement a performance management system in harvesting operations.

$$TDH = (\text{ton/hour}) / (\text{diesel/ton}) = (\text{ton}^2 / \text{diesel} \cdot \text{hour}) \dots \dots \dots (1)$$

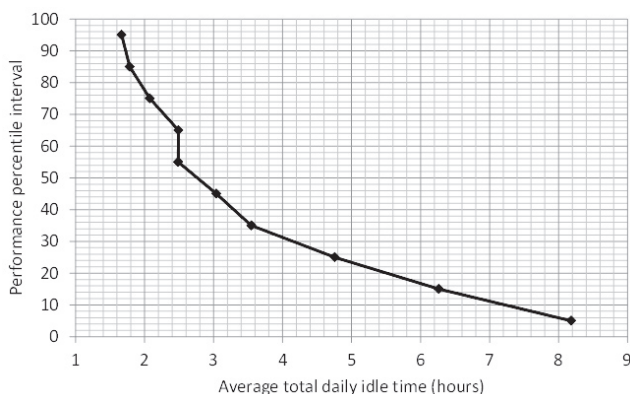
where ton is the tons cane harvested on a particular day, hour is the time taken to perform the operation and diesel is the estimated amount of fuel used.

**Fig. 2** depicts the average TDH index for ten performance percentile intervals (deciles). There is a strong

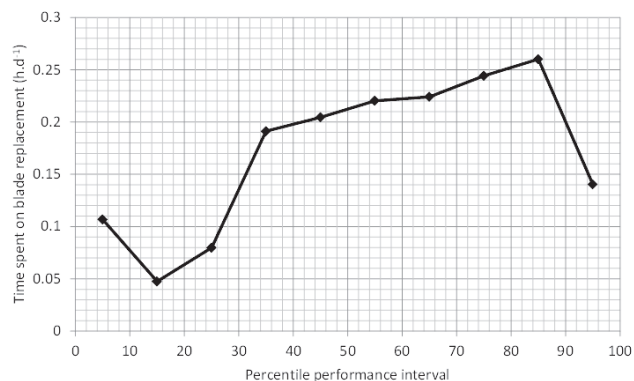
linear response between these two variables, which confirms that the TDH index can be a suitable performance indicator. The calculation of performance percentiles is onerous and can only be done once the dataset is complete, for example at the end of the season. In contrast, the TDH index can be derived at the end of each day's harvesting. This is an interesting discovery and prompts the question whether the TDH index could be used to measure performance in other crops as well, such as corn, wheat and soybean.

**Figs. 3** and **4** depict the relationships between total idle time and blade replacement idle time against harvester performance (percentile interval), respectively. A logarithmic relationship between total idle time and machine performance exists, where machine performance increases exponentially against decreasing idle times. This trend is probably attributed to the fact that once a machine has been working for a number of hours, the operation appears to pick up momentum. The operator probably becomes more familiar to the field, the infield tractor-trailer units start synchronizing with the harvester and the overall system becomes more efficient. From these results it is recommended that the harvesting contractor keeps idle

**Fig. 3** The relationship between total idle time per day and average overall harvester performance (expressed as a percentile of maximum daily performance)



**Fig. 4** The relationship between harvester performance (expressed as a percentile of maximum daily performance) and average blade replacement time



times below three hours and should probably also avoid multiple short idles through the day.

**Fig. 4** depicts a general increase in harvesting performance with an increase in blade replacement time. The blade replacement time includes time spent to do blade sharpening and blade rotation. In contrast to total idle time (**Fig. 3**), regular delays to perform blade management supports better performance. It is noted that blade replacement time was not necessarily a determining factor during the worse (< 20) and during the best performance intervals (> 90). These levels of performance were probably regulated by other factors, such as field conditions and cane yield, however, blade management appears to promote the better overall performance of equipment and need to be investigated carefully in terms of economic feasibility.

**Fig. 5** depicts the average diesel consumption against the average daily breakdown downtime for each harvester in the fleet. Although the slope of the trend line is not significantly positive, a correlation coefficient of 0.62 suggests that higher diesel consumption instances are associated with breakdowns. The cause of this is two-fold. First, it is intuitive that an engine in trouble is likely to increase fuel consumption. If monitored correctly, this informa-

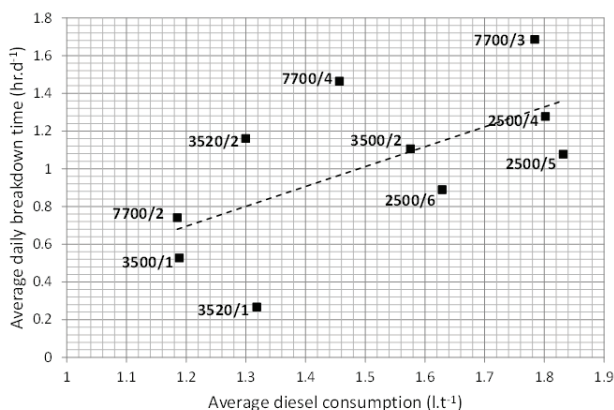
tion could be used to do preventative maintenance. Secondly, on a per ton basis, smaller machines, such as the CHOPPER 2500 models, work harder and will over time result in more breakdowns.

**Fig. 6** reflects a Kamada-Kawai (1989) energized correlation graph of harvesters. Two distinct clusters of harvesters exist where harvesters inside each cluster are generally positively correlated. On consultation with the operation manager, it was noted that the equipment in the light grey cluster were generally considered as high performance equipment, while machines in the dark grey cluster experienced several breakdowns and disruptions through the 2011 and 2012 seasons. This result helps to summarize and categorize the overall performance of each harvester in terms of all 13 descriptive variables listed in **Table 1**. From a management perspective, **Fig. 2** provides a quick and easily interpretable map of harvesters in relation to each other. By generating correlation graphs like this on a regular basis, management could monitor whether a harvester retains its position in terms of a large number of performance variables. Likewise, management could also use this information to identify and focus on anomalies in the system, such as the two harvesters (2500/6 and 3500/2)

that are outliers in the graph.

Similarly to **Fig. 6**, **Fig. 7** depicts an energized correlation graph of different sites where harvesters have operated during the 2011-2012 seasons. Random codes are displayed to protect the identity of clients. The maximal spanning tree algorithm (Heimo *et al.*, 2009) was applied to reduce the number of edges between sites. In the tree structure, sites that are adjacent to each other, such as “PRG” and “PRS”, could be expected to have experienced similar operating conditions (in terms of the 16 descriptive variables listed in **Table 2**). The cluster of sites highlighted in light grey represents relatively small operations where no idle times were captured. It is the absence of idle times that caused these sites to artificially cluster together. The cluster of sites highlighted in dark grey represents all the relatively large operations in the system. Large operations were generally more efficient due to economies of scale and probably the contractor’s effort to keep large clients satisfied. No other logical grouping of sites could be identified in the graph, including geographical location, which seems to play no major role in harvester efficiency in Mauritius. This was interesting since different geographical locations would imply delivery to different mills and dif-

**Fig. 5** Average diesel consumption per harvester against the machine’s average daily breakdown time



**Fig. 6** An energized correlation graph of mechanical harvesters. Dark lines depict strong correlation between harvesters, while dashed lines depict negative correlation values



ferent climatic conditions, however, the influence of these factors appears negligible. The tree structure provides sufficient information for the contractor to focus his investigation and to determine why certain sites are similar or different to each other.

## Discussion and Conclusions

Although harvesting contractors often store large amounts of data for accounting purposes, there appears to be a significant opportunity to study these records for performance related analyses. This, however, may require a large amount of data reformatting and conversion exercises. Correlation analysis forms a solid platform from where specific patterns and peculiarities in the data could be detected and further investigated. Correlation analysis can be enhanced through the use of more powerful correlation graph projections and perhaps principle component analyses.

The calculation of a performance percentile, which is the percentile value after daily machine outputs have been ranked from the lowest to the highest, is a valuable system variable and enables the researcher to make comparisons between har-

vesters. The TDH index, a ratio of harvesting rate to diesel consumption, was also found to be a potentially valuable and robust performance variable. There is scope for this index to be further investigated under different harvesting conditions and even in other crops.

This study confirms a trend of improved harvester performance when blade maintenance is intensified. Blade maintenance, however, also needs to be economically justified. The study uncovered an exponential rise in machine performance against a linear reduction in total idle time. This proposes that sugarcane harvesting needs time to pick up momentum and that regular interruptions may cause significant performance losses. Once a certain amount of time of continuous harvesting has been achieved, it appears that the synchronization of in-field equipment and perhaps the operator's approaches become more harmonious. Another trend, which was not as strong as some of the other findings in this study, was a positive correlation between diesel consumption and equipment breakdowns. Rising diesel consumption rates may be an early indicator of mechanical failure, but more research is warranted to investigate the viability of a management strategy based on this phenomenon.

In this paper we demonstrated how a transposed matrix of normalized descriptive variables could be applied to study the multivariate structures between individual entities in a system, such as harvesters and harvesting sites. These results provided a powerful, yet

easily interpretable, outputs that could help management to monitor performance and to focus on particular outliers within the system. Harvesters were classified into three groups, viz. (a) high performance equipment, (b) poor performance equipment and (c) outliers. A normalized transposed variable correlation graph of harvesting sites confirmed that large operations, such as sugarcane estates, resulted in similar levels of performance, regardless of the mill or geographical location of these sites. This suggests that, for this study, economies of scale tend to override climatic and local milling factors.

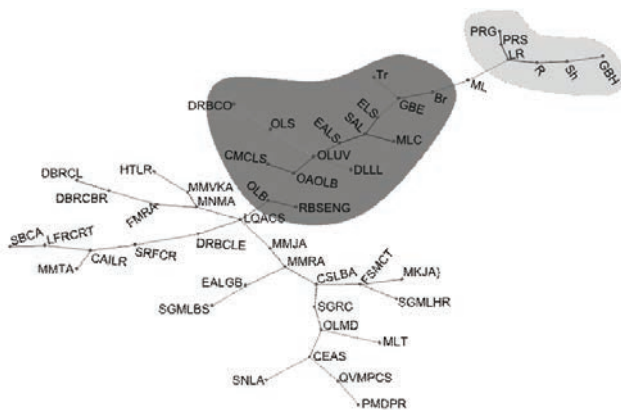
## Acknowledgements

The authors would like to thank CEAL, in particular Mr. Jean-Francois Lagesse, for the sharing of large amounts of performance data and for providing the infrastructure and support to enable this research. Mr. Richard Hill, operation manager from CEAL also provided valuable insights and comments. This research was made possible through the generous support and sabbatical leave that was mutually granted within a collaborative agreement between the University of KwaZulu-Natal and the South African Sugarcane Research Institute.

## REFERENCES

- Braunbeck, O., A. Bauen, F. Rosillo-Calle, and L. Cortez. 1999. Prospects for green cane harvesting and cane residue use in Brazil, *Biomass and Bioenergy*, (17)6: 495-506.
- Çiflikli, C. and E. Kahya-Özyirmidokuz. 2010. Implementing a data mining solution for enhancing carpet manufacturing productivity, *Knowledge-Based Systems*, (23)8: 783-788.
- De Beer, A. G. and T. C. Boevy. 1977. Field efficiency of chopper harvesters. *Proceedings of the*

Fig. 7 A maximal spanning tree of different sites where sugarcane harvesters operated in Mauritius



- South African Sugar Technologists' Association, 19-20, South Africa.
- Domínguez, M., J. J. Fuertes, I. Díaz, M. A. Prada, S. Alonso, and A. Morána. 2012. Monitoring industrial processes with SOM-based dissimilarity maps, *Expert Systems with Applications*, (39)8: 7110-7120.
- Gorban, A. N., E. V. Smirnova, and T. A. Tyukina. 2010. Correlations, risk and crisis: From physiology to finance, *Physica A: Statistical Mechanics and its Applications*, (389): 3193-3217.
- Heimo, T., K. Kaski, and J. Saramäki. 2009. Maximal spanning trees, asset graphs and random matrix denoising in the analysis of dynamics of financial networks, *Physica A: Statistical Mechanics and its Applications*, (388)2-3: 145-156.
- Higgins, A., G. Antony, G. Sandell, I. Davies, D. Prestwidge, and B. Andrew. 2004. A framework for integrating a complex harvesting and transport system for sugar production, *Agricultural Systems*, (82) 2: 99-115.
- Hsu, C. H. 2009. Data mining to improve industrial standards and enhance production and marketing: An empirical study in apparel industry, *Expert Systems with Applications*, (36)3: 4185-4191.
- Kamada, T., and S. Kawai. 1989. An algorithm for drawing general undirected graphs, *Information Processing Letters*, (31): 7-15.
- Kivijärvi, H. and M. Tuominen. 1996. A decision aid in strategic planning and analysis of a wood-processing company. *Proceedings of the 19th International Conference on Computers and Industrial Engineering*, (31)1-2: 467-470.
- Köksal, G., I. Batmaz, and M. C. Testik. 2011. A review of data mining applications for quality improvement in manufacturing industry, *Expert Systems with Applications*, (38)10:13448-13467.
- Le Gal, P.-Y., J. le Masson, C. N. Bezuidenhout, and L. F. Lagrange. 2009. Coupled modeling of sugarcane supply planning and logistics as a management tool. *Computers and Electronics in Agriculture*, 68: 168-177.
- Li, S. P., Y. M. Meng, F. L. Ma, H. H. Tan, and W. X. Chen. 2002. Research on the working mechanism and virtual design for a brush shape cleaning element of a sugarcane harvester, *Journal of Materials Processing Technology*, (129)1-3: 418-422.
- Onnela, J. P., K. Kaski, and J. Kertész. 2004. Clustering and information in correlation based financial networks, *European Physical Journal*, (38): 353-362 353.
- Salassi, M. E., J. B. Breaux, and C. J. Naquin. 2002. Modeling within-season sugarcane growth for optimal harvest system selection, *Agricultural Systems*, (73)3: 261-278.
- Samkange, K. and C. N. Bezuidenhout. 2013. The use of network analysis techniques to identify opportunities for system performance improvement in the Komati transport system. *Proceedings of the South African Sugar Technologists' Association*, South Africa.
- Stray, B. J., J. H. van Vuuren, and C. N. Bezuidenhout. 2012. An optimisation-based seasonal sugarcane harvest scheduling decision support system for commercial growers in South Africa, *Computers and Electronics in Agriculture*, (83): 21-31.
- Viator, R. P., E. P. Richard, B. J. Viator, W. Jackson, H. L. Waguespack, and H. S. Birkett. 2007. Sugarcane chopper harvester extractor fan and ground speed effects on yield and quality, *Applied Engineering in Agriculture*, (23)1: 31-34. ■■

---

## News

---

**Electronic version of AMA journal is now available  
at "Amazon kindle store"**



# Design and Development of a Desiccant Integrated Solar Dryer



by  
Nitesh  
M. Tech Student



Y. K. Yadav  
Professor

Department of Processing & Food Engineering, College of Agricultural Engineering & Technology, Choudhary Charan Singh Haryana Agricultural University, Hisar-125 004, INDIA  
profkyadav@yahoo.co.in

## Abstract

Desiccant integrated solar dryer was designed, developed and its performance was studied under the climatic conditions of Hisar, India. The system consisted of flat plate solar collector, drying chamber and desiccant unit. The desiccant unit was integrated within the drying system to continue the drying process during off sunshine hours at night. During Sunshine hours, the average drying air temperature and collector thermal efficiency of dryer were 48.1 °C and 62.12 % at air mass flow rate of 0.020 kg/s. During off-sunshine hours, the average dryer temperature was 6.2 °C higher than the average ambient temperature and average RH of dryer was lower by 12.9 % than average ambient RH showing the potential of desiccant integrated solar dryer for drying of food material even during night time operations.

## Introduction

Drying is an essential process in the preservation of agricultural products. Food products, especially fruits and vegetables require hot air in the temperature range of 45-60 °C for safe drying. Drying under

controlled conditions of temperature and humidity helps the agricultural food products to dry reasonably rapidly to safe moisture content and to ensure a superior quality of the product (Sharma *et al.*, 2009).

Active solar dryers are designed incorporating external means like fans or blowers, for moving the solar energy in the form of heated air from the collector area to the drying beds (Mohanraj and Chandrasekar, 2009). The inclusion of desiccants continues the drying process into the night reducing the overall drying time. Desiccant drying involves forcing air through a packed bed of solar-regenerated desiccant to adsorb moisture from the wet crop (Hodali and Bougard, 2001).

Several studies have been conducted using regenerated solid desiccants such as silica gel, but it requires high temperature typically above 150 °C for regeneration and high cost of desiccant material. Though silica gel has a high moisture sorption capacity but its dust particles have shown to be carcinogenic thus making it unsuitable for direct food processing applications. Efficacy of various CaCl<sub>2</sub> based solar regenerative solid desiccant material is high and suitable for drying applications of fruits and vegetables. (Throwa *et al.*, 1996).

The integration of desiccant unit with solar drying continues the drying of products in the off-sunshine hours and improves the quality of dried product (Shanmugam and Natarjan, 2007). The study was undertaken to extend the solar based drying into night time operations. The main objective of the study was to design, develop and evaluate the performance of a solid desiccant integrated solar dryer.

## Materials and Methods

### Design Analysis:

The mass of water to be removed during drying  $M_w$ , kg

$$M_w = [(m_i - m_f) / (100 - m_f)] \times W$$

$m_i$  = Initial moisture content

$m_f$  = Final moisture content

$W$  = Weight of product

### Flat Plate Solar Collector

60 % of moisture is removed by air heated using solar energy and remained 40% by the desiccant following Shanmugam and Natarajan (2007).

$$M_1 = 0.6 \times M_w$$

$$M_2 = 0.4 \times M_w$$

Mass of water removed per hour  $m_1$ , kg / hr

$$m_i = M_1 / t_d$$

$t_d$  = solar drying time, hours.



Total energy required E, kcal  
 $E = W \times C_p \times (T_d - T_a) + (m_l \times \lambda)$   
W = Weight of product, kg  
 $C_p$  = Specific heat of water, kcal / kg °C  
 $T_d$  = Drying air temperature, °C  
 $T_a$  = Ambient temperature, °C  
 $M_w$  = Mass of water to be removed during drying, kg  
 $\lambda$  = Latent heat of vaporization, kcal/kg  
Area of flat plate collector,  $A_c$   
 $A_c = E / (\eta \times I)$   
I = Insolation, W/m<sup>2</sup>  
 $\eta$  = Efficiency of flat plate collector  
Air mass flow rate, Ma kg / hr  
 $M_a = E / [C_a \times \rho_a \times (T_d - T_a) \times t_d]$   
 $C_a$  = Specific heat capacity of air, kcal/kg °C  
 $\rho_a$  = density of air, kg/m<sup>3</sup>

### Desiccant Unit

Amount of moisture to be removed by desiccant bed is 40 %  
 $M_2 = 0.4 \times M_w$   
Drying time for desiccant unit = 12 hrs (assumed)  
Moisture removal rate,  $m_{des} = M_2 / t_{des}$   
Maximum heat release in desiccant bed =  $(m_{des} \times 2400) / (1000$

**Table 1** Considerations for design of desiccant integrated solar dryer

Material	Green peas
Weight of material	10 kg
Initial Moisture Content	75 % (wb)
Final Moisture Content	5 % (wb)
Location	Hisar
Latitude	29°10'N
Longitude	75°46'E
Average solar insolation	700 W/m <sup>2</sup>
Sunshine hours	10
Off-sunshine hours	12
Latent heat of vaporization	2.383 kJ/kg
Density of air	1.115 kg/m <sup>3</sup>
Efficiency of flat plate solar collector	45 %
Specific heat of water	1.0 kcal/kg °K
Avg. Drying Temperature	50 °C
Avg. ambient temperature	35-40 °C
Desiccant dimensions	10 cm length and 1 cm dia

$\times 3600)$ , kW

It was determined through regeneration studies that 1 kg of developed desiccant adsorbed 140 g of moisture in 12 hours at 30 °C.

Amount of desiccant required  $W_{des}$ , kg =  $M_2 / \text{Moisture absorb by 1 kg desiccant}$

One desiccant piece has dimensions of 10 cm length and 1 cm diameter weighs an average of 20 gm.

No. of desiccant required =  $W_{des} / \text{weight of one piece of desiccant}$

### Development Of Desiccant Material

Forty kg of solid desiccant was prepared from 60 % bentonite clay, 10 % calcium chloride, 20 % vermiculite and 10 % cement and moulded in shape of cylinders of 10 cm length and 1 cm diameter. The moulded cylindrical desiccant pieces were kept at 200 °C for 24 hours in oven and the regeneration studies were done in two phases, adsorption studies and desorption studies.

### Desiccant Integrated Solar Dryer

The developed desiccant integrated solar dryer consisting of a flat plate solar collector, drying chamber and desiccant unit is shown in **Fig. 1**.

The dimension of flat plate solar collector is 2 m × 1 m and is tilted at an angle of 30°. A 5 mm plain window glass was used as transparent cover to avoid heat losses at the top. The collector air channel depth is 9 cm and the space between the absorber to the transparent glass cover

**Table 2** Design Specification of desiccant integrated solar dryer

Particulars	Specifications
Collector area	2 m × 1 m
Air mass flow rate	0.010 kg/s
Drying unit dimensions	100 cm × 100 cm × 50 cm
Drying tray area	90 cm × 45 cm
No. of trays	5
Desiccant unit dimensions	100 cm × 58 cm × 15 cm
Amount of desiccant	40 kg
No of desiccants	2000

is 9 cm. A metal sheet painted matte black is used as an absorber plate to absorb incident solar radiation. The drying chamber of dimension 1 m × 0.5 m × 1 m was loaded with five trays (90 cm × 45 cm × 10 cm) fabricated from plywood and wire mesh (12 × 12) attached to them. Desiccant unit was fabricated on the top of the drying unit with dimensions 100 cm × 58 cm × 15 cm. Double glazing was provided at the top of the desiccant unit with an air gap of 2.54 cm and inclined at 30° like flat plate solar collector in order to increase the total energy collected and to reduce the net thermal loss from the desiccant bed. A perforated sheet was provided to hold 40 kg of solid desiccants below the double glazing. The space between the bottom glass cover and the desiccant bed was 10 cm. Two plywood sheets of 10 mm thickness and sliding over each other were used as separator between drying unit and desiccant unit such that they have circular openings of 4 cm diameter, one plywood sheet is fixed and other for sliding over the fixed sheet with the help of handle for opening and closing between desiccant unit and drying unit. Three centrifugal fans of 100 W each were provided in the desiccant integrated solar dryer maintaining static air mass flow rate through collector, another fan was used for the desiccant unit to remove humid air from it during sunshine hours and the third fan works during off-sunshine hours to make closed loop between drying unit and desiccant unit to pass the air through desiccant bed such that air dehumidifies there and moisture is absorbed by desiccant. The dehumidified air is used to continue drying of food material during off-sunshine hours.

### Results and Discussion

To evaluate the performance of desiccant integrated solar dryer

without load, the air temperature and RH were recorded with digital thermo-hygrometer at various positions in desiccant integrated solar dryer viz. ambient, collector outlet, drying chamber and desiccant unit. The insolation was measured with digital solar intensity meter at a regular interval of time.

### Performance of Desiccant Solar Dryer During Sunshine Hours

The performance of desiccant integrated solar dryer at air mass flow rate of 0.020 kg/s at no load condition during the month of May on a typical day (May 10, 2012) was carried out and shown in Fig. 2. The maximum (992 W/m<sup>2</sup>) insolation

recorded was at 12:00 hrs whereas maximum ambient temperature, collector outlet temperature, dryer temperature and desiccant temperature were 40.0 °C, 61.0 °C, 60.0 °C, 64.0 °C, respectively at 14:00 hrs during the sunshine hours.

### Effect of Air Mass Flow Rate on Drying Air Temperature and Collector Thermal Efficiency

The drying air temperature and collector thermal efficiency variation with time at three different air mass flow rates is shown in Fig. 3. At air mass flow rate of 0.010 kg/s the drying air temperature increased from 33.0 °C at 8:00 hrs to 68.0 °C at 14:00 hrs and the collector ther-

mal efficiency increased from 23.90 % at 8:00 hrs to 54.02 % at 14:00 hrs. After that the drying air temperature decreased to 37.3 °C and collector thermal efficiency to 39.23 % at 18:00 hrs. At air mass flow rate of 0.015 kg/s, the drying air temperature increased from 32.0 °C at 8:00 hrs to 65.0 °C at 14:00 hrs and the collector thermal efficiency increased from 24.83 % at 8:00 hrs to 72.94 % at 14:00 hrs. After that the drying air temperature decreased to 38.0 °C and collector thermal efficiency to 42.84 % at 18:00 hrs. At air mass flow rate of 0.020 kg/s the drying air temperature increased from 32.0 °C at 8:00 hrs to 61.0 °C at 14:00 hrs and the collector thermal efficiency increased from 37.29 % at 8:00 hrs to 83.03 % at 14:00 hrs. After that the drying air temperature decreased to 36.0 °C and collector thermal efficiency to 49.90 % at 18:00 hrs. The experimental results show that drying air temperature and collector thermal efficiency were dependent on the air mass flow rates. The average drying air temperature was 53.3 °C, 51.2 °C and 48.1 °C and the average collector thermal efficiency was 41.98 %, 52.24 % and 62.18 % at air mass flow rate of 0.010 kg/s, 0.015 kg/s and 0.020 kg/s, respectively.

As the drying air temperature increased from 08:00 hrs to 14:00 hrs the collector efficiency increased to maximum and decreased as drying air temperature decreased from 14:00 hrs to 18:00 hrs. The minimum collector efficiency was 23.90 %, 24.83

Fig. 1 Developed desiccant integrated solar dryer showing drying chamber and desiccant unit



Fig. 2 Hourly variation of insolation and temperature during sunshine hours

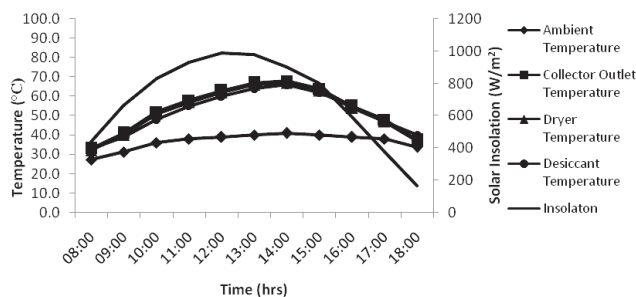
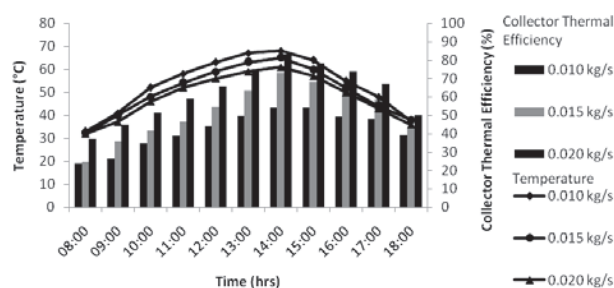


Fig. 3 Variation of drying air temperature and collector thermal efficiency



% and 37.29 % at 8:00 hrs and the maximum collector efficiency was 54.02 %, 72.94 % and 83.03 % at 14:00 hrs at air mass flow rate 0.010 kg/s, 0.015 kg/s and 0.020 kg/s, respectively. The drying air temperature and collector thermal efficiency were dependent on the air mass flow rate. The average collector thermal efficiency was 41.98 %, 52.24 % and 62.18 % at air mass flow rate 0.010 kg/s, 0.015 kg/s and 0.020 kg/s, respectively. Similar trends were observed by Yeh and Lin (1996).

### Day and Night Performance of Desiccant Integrated Solar Dryer

The day and night performance of desiccant integrated solar dryer is presented in Fig. 4. During sunshine hours, the ambient temperature increased from 27.0 °C at 8:00 hrs to 40.0 °C at 14:00 hrs and then decreased to 34.0 °C at 18:00 hrs whereas the ambient RH decreased from 31.0 % at 8:00 hrs to 15.0 % at 14:00 hrs and then increased to 22.0 % at 18:00 hrs. The average ambient temperature and RH were 35.6 °C and 20.6 %, respectively. The dryer temperature was increased from 32.0 °C at 8:00 hrs to 61.0 °C at 14:00 hrs and then decreased to 36.0 °C at 18:00 hrs whereas the RH decreased from 25.0 % at 8:00 hrs to 13.0 % at 14:00 hrs and then increased to 22.0 % at 18:00 hrs. The average dryer temperature and RH were 48.1 °C and 17.7 %, respectively. The desiccant bed temperature showed the similar variation as that of dryer. The average dryer

temperature was 12-16 °C higher by average ambient temperature.

Fig. 4 further shows that during off-sunshine hours, the ambient temperature decreased from 34.0 °C 18:00 hrs to 21.0 °C at 6:00 hrs whereas the RH increased from 22.0 % at 18:00 hrs to 53.0 % at 6:00 hrs. The average ambient temperature and RH were 26.4 °C and 35.2 %, respectively. The dryer temperature decreased from 37.0 °C at 18:00 hrs to 30.5 °C at 6:00 hrs and RH increased from 20.0 % at 18:00 hrs to 25.0 % at 6:00 hrs. The average dryer temperature and RH were 32.6 °C and 22.2 %, respectively. The average dryer temperature was 6.2 °C higher than the average ambient temperature and average RH of dryer was lower by 12.9 % than average ambient RH showing the potential of desiccant integrated solar dryer for drying of food material even during night time operations.

### Conclusions

The collector outlet and dryer temperature were nearly equal, showing the thermal stability of desiccant integrated solar dryer. The performance results of desiccant integrated solar dryer showed that ambient temperature, solar insolation and air mass flow rate have influence on drying air temperature and collector thermal efficiency. The average collector outlet temperatures were 53.3 °C, 51.2 °C and 48.1 °C and average collector thermal efficiency was 41.98 %, 52.24

% and 62.18 % at air mass flow rate of 0.010 kg/s, 0.015 kg/s and 0.020 kg/s, respectively.

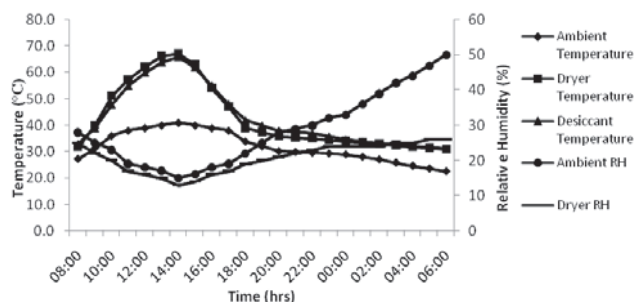
It was observed that the temperature attained in desiccant unit with solar energy

was sufficient for the regeneration of the developed desiccant material. Temperature inside the desiccant integrated solar dryer was maintained above 31.0 °C during off-sunshine hours. The average dryer temperature was 5-8 °C higher than average ambient temperature during night time showing the drying potential during off-sunshine hours. From this study it is concluded that desiccant integrated solar dryer may reduce the drying time and hence is a competitive alternative for solar drying.

### REFERENCES

- Hodali R. and J. Bougard 2001. Integration of a desiccant unit in crops solar drying installation: optimization by numerical simulation. *Energy Conversion and Management*, 42(13): 1543-1558.
- Mohanraj, M. and P. Chandrasekar. 2009. Performance of a forced convection solar drier integrated with gravel as heat storage material for chili drying. *Journal of Engineering Science and Technology*, 4(3): 305-314.
- Shanmugam, V. and E. Natarajan. 2007. Experimental study of regenerative desiccant integrated solar dryer with and without reflective mirror. *Applied Thermal Engineering*, 27(9): 1543-1551.
- Sharma, A., C. R. Chen, and V. N. Lan. 2009. Solar energy drying systems: A review. *Renewable and Sustainable Energy Reviews* 13(7): 1185-1210.
- Thoruwa, T. F. N., J. E. Smith, A. D. Grant, and C. M. Johnstone. 1996. Developments in solar drying using forced ventilation and solar regenerated desiccant materials. *Proceedings World Renewable Energy Congress IV held at Denver, USA during 15-21 June, 1996*.
- Yeh, H. M. and T. T. Lin. 1996. Efficiency improvement of flat-plate solar air heaters. *Energy*, 26(6): 435-443. ■■

Fig. 4 Variation in temperature and RH during sunshine hours and off-sunshine hours





# Co-operating Editors



B Kayombo



M F Fonteh



S E Abdallah



A A K El Behery



R J Bani



I K Djokoto



D K Some



K Houmy



O A Oyelade



Umar B Bindir



J C Igbeka



E U Odigboh



K C Oni



U L Opara



N G Kuyembah



A H Abdoun



A B Saeed



A I Khatibu



S Tembo



H A Cetrangolo

## -AFRICA-

### Benedict Kayombo

Assoc. Prof. of Soil and Water Engg., Dept. of Agric. Engg. and Land Planning, Botswana College of Agric., Univ. of Botswana, Private Bag 0027, Gaborone, BOTSWANA. TEL+267-3650125, bkayombo@bca.bw

### Mathias Fru Fonteh

Assoc. Prof. and Head, Dept. of Agril. Engg., Faculty of Agronomy and Agril. Sciences, Univ. of Dschang, P.O. Box 447, Dschang, West Region, CAMEROON. TEL+237-7774-0863, matfonteh@yahoo.com

### Said Elshahat Abdallah

Assoc. Prof. of Agril. & Biological Process Engg., Dept. of Agril. Engg., Faculty of Agric., Kafrelsheikh Univ., Kafr Elsheikh 33516, EGYPT. TEL+20-473-14-8949, saidelshahat@agr.kfs.edu.eg

### Ahmed Abdel Khalek El Behery

Agric Engg. Research Institute, Agril. Reserch Center, Nadi El-Said St. P.O. Box 256, Dokki 12311, Giza, EGYPT. behery28@yahoo.com

### Richard Jinks Bani

Lecturer & Co-ordinator, Agric. Engg. Div., Faculty of Agric., Univ. of Ghana, Legon, GHANA

### Israel Kofi Djokoto

Prof., Israel Kofi Djokoto, Associate Prof. Univ. of Science and Technology, P.O.Box 420 ust, Kumasi, GHANA, profdjokoto@yahoo.com

### David Kimutaiarap Some

Eng. Prof. Dept. of Agril & Biosystems Engg., School of Engg Chepkoilel University College of Moi Univ., P.O. Box: 2405-30100, Eldoret, KENYA, dkimutai-some2@gmail.com

### Karim Houmy

Prof. and head of the Farm Mechanization Dept., Institute of Agronomy and Velerinary Medicine II, Secteur 13 Immeuble 2 Hay Riad, Rabat, MOROCCO. TEL+212-7-680512, houmy@maghrebnet.net.ma

### Opeyemi Adeniyi Oyelade

Obtaining Doctor, Farm Power and Machinery Department, National Centre for Agricultural Mechanization (NCAM), P.M.B. 1525, Ilorin, Kwara

State, NIGERIA. TEL+2348069030588, yemibamig-bedjoyelade@gmail.com

### Umar Buba Bindir

Director General/CEO, National Office for Technology Acquisition and Promotion, No 4. Blantyre Street, Wuse II PMB 5074, Abuja, FCT Federal Republic of NIGERIA. TEL+234-9461-1183, ubindir@yahoo.com

### Joseph Chukwugotium Igbeka

Prof., Dept. of Agril. Engg., Univ. of Ibadan., Ibadan, NIGERIA. TEL+234-2-810-1100-4, Library@ibadan.ac.ng

### Emmanuel Uche Odigboh

Prof., Agril. Engg Dept., Faculty of Engg., Univ. of Nigeria, Nsukka, Enugu state, NIGERIA. TEL+234-042-771676, MISUNN@aol.com

### Kayode C. Oni

Department of Agricultural & Biosystems Engineering, Faculty of Engineering & Technology, University of Ilorin, PMB 1515, Ilorin, NIGERIA. TEL+234-803-5724708, kayoroll@gmail.com

### Umezuruik L. Opara

Research Prof., S. Africa Research Chair in Post-harvest Technology, Faculty of AgriSciences, Stellenbosch Univ., Private Bag X1, Stellenbosch 7602, SOUTH AFRICA. TEL+27-21-808-4604, opara@sun.ac.za

### Nathaniel Gbahama Kuyembah

Assoc. Prof., Njala Univ. Colle, Univ. of Sierra Leone, Private Mail Bag, Free Town, SIERRA LEONE. TEL+249-11-778620/780045

### Abdien Hassan Abdoun

Member of Board, Amin Enterprises Ltd., P.O. Box 1333, Khartoum, SUDAN.

### Amir Bakheit Saeed

Assoc. Prof., Dept. of Agric. Engg., Faculty of Agric., Univ. of Khartoum, 310131 Shambat, SUDAN. TEL+249-11-310131, absaeed5@yahoo.com

### Abdisalam I. Khatibu

P. O. Box 2138, Zanzibar, TANZANIA. khatibu@zansec.com

### Solomon Tembo

52 Goodrington Drive, PO Mabelreign, Sunridge, Harare, ZIMBABWE.

## -AMERICAS-

### Hugo Alfredo Cetrangolo

Full Prof. and Director of Food and Agribusiness Program Agronomy College Buenos Aires Univ., Av. San Martin 4453, (1417) Capital Federal, ARGENTINA. TEL+54-11-4524-8041/93, cetrango@agro.uba.ar

### Irenilza de Alencar Nääs

Prof., Agril. Engg. College, UNICAMP, Agril. Construction Dept., P.O. Box 6011, 13081 -Campinas-S.P., BRAZIL. TEL+55-19-788-1039, irenilza@agr.unicamp.br

### Abdelkader E. Ghaly

Prof., Biological Engg. Department Dalhousie Univ., P.O. Box 1000, Halifax, Nova Scotia, B3J2X4, CANADA. TEL+1-902-494-6014, abdel.ghaly@dal.ca

### Edmundo J. Hetz

Prof., Dept. of Agric. Eng. Univ. of Concepcion, Av. V. Mendez 595, P.O. Box 537, Chillan, CHILE. TEL+56-42-216333, ehetz@udec.cl

### Marco A. L. Roudergue

Mechanization and Energy Dept., Agril. Engg. Faculty, Campus Chillan, Univ. of Concepcion, Chile. Vicente Mendez #595, Chillan, CHILE. TEL+56-42-2208709, FAX./2275303, malopez@udec.cl

### Roberto Aguirre

Assoc. Prof., National Univ. of Colombia, A.A. 237, Palmira, COLOMBIA. TEL+57-572-271-7000, FAX./4235, ra@palmira.unal.edu.co

### Omar Ulloa-Torres

Prof., Escuela de Agricultura de la Region, Tropical Humeda (EARTH), Apdo. 4442- 1000, San Jose, COSTA RICA. TEL+506-255-2000, o-ulloa@ns.earth.ac.cr

### S. G. Campos Magaña

PhD and Professor, Paseo de los Claveles #398, Colonia Parques de la Cañada. CP 25080, Saltillo, Coahuila, MEXICO. camposg\_1999@yahoo.com



I de A Nääs



A E Ghaly



E J Hetz



M A L Roudergue



R Aguirre



O Ulloa-Torres



S G C Magana



H Ortiz-Laurel



G C Bora



W J Chancellor



M R Goyal



A K Mahapatra



Surya Nath



S M Farouk



Daulat Hussain



M A Mazed



Chetem Wangchen



M A Basunia



Li Shujun



S Illangantileke



S M Ilyas



Indra Mani



C R Mehta



A M Michael



T P Ojha



B S Pathak



V M Salokhe



G Singh



S R Verma



Kamaruddin Abdullah

### Hipolito Ortiz-Laurel

Head of Agric. Engg. and Mechanization Dept./ Postgraduate College, Iturbide 73, Salinas de Hgo, S.L.P., C.P. 78600, MEXICO. TEL+52-496-30448.

### Ganesh C. Bora

Assistant Prof. and Interim Director, Machinery Systems and Precision Agriculture, Dept. of Agril. and Biosystems Engg., North Dakota State Uni. (NDSU), Fargo, ND 58108-6050, U.S.A. TEL+1-701-231-7271, ganesh.bora@ndsu.edu

### William J. Chancellor

Prof. Emeritus, Bio. and Agr. Eng. Dept., Univ. of California, Davis, CA, 95616, U.S.A. TEL+1-530-753-4292, wjchancellor@ucdavis.edu

### Megh R. Goyal

Senior Acquisitions Editor, Agric. & Biomedical Engineering and Retired Professor in Agric. & Biomedical Eng. Univ. of Puerto Rico, Mayaguez P.O. BOX 86, Rincon, PR-00677, U.S.A. m\_goyal@ece.uprm.edu

### Ajit K. Mahapatra

Agric. & Biosystems Eng. Dept., South Dakota State Univ., P.O. Box 2120 Brookings, SD 57007-1496, U.S.A. TEL+1-605-688-5291, mahapata@sdstate.edu

### Surya Nath

2929 Mc Gee Trfwy, #401, Kansas City, Missouri, 64108, U.S.A. drmath.surya@gmail.com

## -ASIA and OCEANIA-

### Shah M. Farouk

Prof. (Retd.), Farm Power & Machinery Dept., Bangladesh Agril. Univ., Mymensingh 2202, BANGLADESH. TEL+880-1711-801923, smf1941@yahoo.com

### Daulat Hussain

Dean, Faculty of Agric. Engg. and Technology, Bangladesh Agril. Univ., Mymensingh-2202, BANGLADESH. TEL+880-91-52245

### Mohammed A. Mazed

Member-Director, Bangladesh Agri. Res. Council, Farmgate, Dhaka, BANGLADESH. mamazed@barcbgd.org

### Chetem Wangchen

Programme Director Agril. Machinery Centre Ministry of Agric. Royal Government of Bhutan, Bondey Paro Bhutan 1228, BHUTAN. krtamc@druknet.bt

### Mohammad Ali Basunia

Assistant Prof., Institute Teknologi Brunei (ITB), Jalan Tungku Link, Gadong BE 1410, Brunei Darussalam, BRUNEI, mdalibas@gmail.com

### Li Shujun

President, Chinese Academy of Agril. Mechanization Sciences (CAAMS)/ Asian Association for Agril. Eng. (AAAE), No.1 Beishatan Deshengmen Wai Beijing 100083, CHINA. TEL+86-10-6488-2230, lisj@caams.org.cn

### Sarath G. Illangantileke

Regional Representative for South and West Asia, International Potato Center (CIP), Regional Office for CIP-South & West Asia, IARI (Indian Agric. Res. Institute) Campus, Pusa, New Delhi-12, 110002, INDIA. TEL+91-11-5719601/5731481, cip-delhi@cgjar.org

### S. M. Ilyas

Project Director, DEC, National Institute of Rural Development (NIRD), Rajendranagar, Hyderabad-500030, INDIA. Tel+91-40-2400-8417, smiyas@city.com

### Indra Mani

Prof., Division of Agril. Engineering IARI, New Delhi-110012, INDIA. maniiindra99@gmail.com

### C. R. Mehta

Head, Agril. Mechanisation Division Central Institute of Agricultural Engineering Nabi-bagh, Berasia Road Bhopal-462038, INDIA. TEL+91-755-2747894, crmehta65@yahoo.co.in

### A. M. Michael

1/64, Vattekunnam, Methanam Road, Edappally North P.O., Cochin, 682024, Kerala State, INDIA. kmichael65@eth.net

### T. P. Ojha

Director General(Engg.) Retd., ICAR, 110, Vineet Kung Akbarpur, Kolar Road, Bhopal, 462 023, INDIA. TEL+91-755-290045

### B. S. Pathak

Prof., Director, Sardar Patel Renewable Energy Research Institute P.B. No.2, Vallabh Vidyanagar-388 120, (Guj.) INDIA. bspathak@spreri.org

### Vilas M. Salokhe

Prof., Vice Chancellor, c/o Lumino Industries 156 A & B, Rash Behari Avenue Kolkata-700029, INDIA. vsalokhe@yahoo.com

### Gajendra Singh

Adjunct Professor, Indian Agricultural Research Institute (IARI), 86-C, Millennium Apartments, Sector-61, NOIDA, U. P. 201301, INDIA. TEL+91-99-71087591, prof.gsingh@gmail.com

### S. R. Verma

Ex-Dean & Prof. of Agr. Engg., H. No. 14, Good Friends Colony, Barewal Road, Ludhiana 141012. Punjab, INDIA. TEL+91-161-2551096, srverma10@yahoo.com

### Kamaruddin Abkullah

The Graduate School/Renewable Energy, Darma Persada University, Jl. Radin Inten II, Pondok Kelapa, East Jakarta, 13450, INDONESIA. TEL+64-21-8649051, kamaruddinabd@gmail.com

### Mansoor Behroozi-Lar

Prof., Emeritus Tehran Uni. Agr. Engg., Ph. D., Jalal All Ahmad Nasim St. Nasim Danesh Complex Block #35, second floor Tehran, IRAN.

### Saeid Minaei

Assoc. Prof., Dept. of Agr. Machinery Eng., Tarbiat Modarres Univ., P.O.Box 14115-336, Tehran, IRAN. TEL+9821-44180537, minaee@modares.ac.ir

### Ali Mazin Abdul-Munaim

Assistant Prof., Dept. of Agril. Machines and Equipments, College of Agric., Univ. of Baghdad, IRAQ. TEL+964-778-4561, old2a3y@yahoo.com

### Bassam A. Snobar

Prof., Univ. of Jordan, Faculty of Agriculture, Amman 11492, JORDAN. snobar@ju.edu.jo

### Jong Hoon Chung

Prof., Dept. of Biosystems & Biomaterials Science and Engg., College of Agril. and Life Sciences, Seoul National Univ., Bldg 200 Rm 2216 1 Gwanangno, Gwanak-Gu, Seoul, 151-742, KOREA. TEL+82-2-880-4601, jchung@snu.ac.kr

### In-Bok Lee

Prof., Laboratory of Aero-Environmental & Energy Engineering (A3EL), Dept. of Rural Systems Engg., College of Agril. & Life Sciences, Seoul National Univ., San 56-1, Shillim-dong, Gwanak-gu, Seoul-city, KOREA. TEL+82-2-880-4586, iblee@snu.ac.kr

### Muhamad Zohadie Bardaie

Prof., Dept. of Agril. and Biosystems Engg., Univ. Putra Malaysia, 43400 upm, Serdang, Selangor, MALAYSIA. TEL+60-3-8946-6410



M Behroozi-Lar



Saeid Minaei



A M Abdul-Munaim



B A Snobar



J H Chung



In-Bok Lee



M Z Bardaie



M P Pariyar



H P W Jayasuriya



A D Chaudhry





Alamgir A Khan



A Q A Mughal



Rafiq ur Rehman



N A Abu-Khalaf



R M Lantin



R P Ventura



S A Al-Suhaibani



A M S Al-Amri



S F Chang



T S Peng



S Krishnasreni



S Phongsupasamit



A Senanarong



Y Pinar



I Haffar



N Hay



P V Lang



T H Katardjiev



P Kic



J Müller

### Madan P. Pariyar

Consultant, Rural Development through Selfhelp Promotion Lamjung Project, German Technical Cooperation. P.O. Box 1457, Kathmandu, NEPAL.

### Hemanatha P. W. Jayasuriya

College of Agril. and Marine Sciences, P.O. Box 34, PC 123AI-khod, Muscat Sultanate, OMAN. TEL+968-2414-1223, hemjay@squ.edu.om

### Allah Ditta Chaudhry

Dean Faculty of Engg. & Technology, Univ. of Faisalabad, Amin Campus (Boys), West Canal Road, Faisalabad, PAKISTAN. dr.adch@tuf.edu.pk

### Alamgir A. Khan

Research Engineer, Agricultural Mechanization Research Institute, Multan, PAKISTAN. alamgirakhtar@hotmail.com

### A. Q. A. Mughal

Vice Chancellor, Sindh Agr. Univ., Tandojam, 70060. PAKISTAN

### Rafiq ur Rehman

Director, Agril. Mechanization Reserch Institute, P.O. Box No. 416 Multan, PAKISTAN

### Nawaf A. Abu-Khalaf

Assistant Prof., Palestine Technical Univ. -Kadoorie (PTUK), P.O.Box 405, Hebron, West Bank, PALESTINE. TEL+972-2-2227-846/7, nawafu@hotmail.com

### Reynaldo M. Lantin

Prof., College of Engg. and Agro-Industrial Technology Univ. of the Philippines Los Banos, Laguna 4031, PHILIPPINES. TEL+63-49-536-2792

### Ricardo P. Ventura

President & General Manager, Rivelisa publishing House, 215 F, Angeles St. cor Taft Ave. Ext., 1300 Pasay City, Metro Manila, PHILIPPINES.

### Saleh Abdulrahman Al-suhaibani

Prof., Agril. Engg. Dept., College of Agric., King Saud Univ., P.O. Box 2460 Riyadh 11451, SAUDI ARABIA. salsuhaibani@gmail.com

### Ali Mufarreh Saleh Al-Amri

Prof., Dept. of Agril. Systems Engg., College of Agril. Sciences & Food, King Faisal Univ., P.O.Box 55035, Al-Ahsa, 31982 SAUDI ARABIA. aamri@kfu.edu.sa

### Sen-Fuh Chang

Prof., Department of Bio-Industrial Mechatronics Engg., National Taiwan Univ., 136 choushan Road,

Taipei, 106. TAIWAN. sfchang@ntu.edu.tw.

### Tieng-Song Peng

Deputy Director, Taiwan Agril. Mechanization Research and Development Center. FL. 9-6, No. 391 Sinyi Road, Sec. 4, Taipei, 110. TAIWAN.

### Suraweth Krishnasreni

Emeritus Prof. 24/77 Baan Kasemsan 1, Soi Kasemsan 1 Rama 1 Rd., Wangmai, Pathumwan, Bangkok 10330, THAILAND, surin1950@hotmail.com

### Surin Phongsupasamit

President, Institute for Promotion of Teaching Science and Technology, 924 Sukumit Rd. Klong Toey Bangkok, THAILAND

### Akkapol Senanarong

Director, Agril. Engg. Research Institute, Dept. of Agric., Jatuchak Bangkok, 10900, THAILAND. akkapol@ksc.th.com

### Yunus Pinar

Prof. and Head, Trakya Univ., College of Technical Sciences, Dept. of Machine Sarayici Campus, Edirne, TURKEY. ypinar@trakya.edu.tr

### Imad Haffar

Managing Director, Palm Water Jumeirah Village (Site Office Gate #10) Al Khail Road, P.O. Box 215122, Dubai, U.A.E. Tel+971-4-375-1196, imad.haffar@palmwater.ae

### Nguyen Hay

Assoc. Prof., Dean of Faculty of Engg., Nonglam Univ., Linh Trung Ward, Thu Duc District, Ho Chi Minh City, VIET NAM. nguyenhay@hcm.fpt.vn

### Pham Van Lang

Director, Vietnam Institute of Agril. Engg., A2-Phuong Mai, Dong Da Hanoi, VIET NAM. langvcd@yahoo.com

## -EUROPE-

### Tihomir Hristov Katardjiev

General Manager at Yogurtson Trade Ltd., Omachi 216-74, Ichikawa-shi, Chiba-ken 272-0801, Japan (BULGARIA). miro@yogurtson.com

### Pavel Kic

Professor, Czech Univ. of Life Sciences Prague, Faculty of Engg. 16521 Prague 6-Suchdol, CZECH REPUBLIC. TEL+420-2-2438314 kic@tf.czu.cz

### Joachim Müller

Prof. of the Univ. Hohenheim, Institute of Agril. Engg., Head of Agric. I Engg. in the Tropics and Subtropics, Univ. of Hohenheim, 70593 Stuttgart, GERMANY. TEL+49-711-459-22490, joachim.muller@uni-hohenheim.de

### Ettore Gasparetto

Former Professor of Agril. Mechanization, Dept. Agril. Engg., Univ. of Milano, Via Galileo Galilei 17, I-35121 Padova, ITALY. TEL+39-0250316619, etttore.gasparetto@unimi.it

### W. B. Hoogmoed

Univ. Lecturer, Wageningen Univ., Farm Technology Group, P.O.Box 317, 6708 AA Wageningen NETHERLAND. willem.hoogmoed@wur.nl

### Jan Pawlak

Prof., head of the Dept. of Economics and Utilization of Farm Machines at IBMER, Prof. at the Univ. of Warmia and Mazury in Olsztyn, Fac. of Tech. Sci. POLAND. j.pawlak@itep.edu.pl

### Oleg S. Marchenko

Prof. and Agril. Engineer, Dept. Head in All-Russia Research Institute for Mechanization in Agric. (VIM), 1st Institut'sky proezd, 5, Moscow 109428, RUSSIA. TEL+7-926-492-1207, oleg072000@mail.ru

### Milan Martinov

Prof., Faculty of Technical Sciences, Chair for Bio-systems Engg., Novi Sad, SERBIA. TEL+ 381-21-485-2369, Milan.Martinov@uns.ac.rs

### Jaime Ortiz-Cañavate Puig-Mauri

Dpto. Ingenieria Rural Universidad Politécnica de Madrid, Esc. T. S. Ing. Agrónomos 28040-Madrid SPAIN. TEL+34-91-336-5852, jaime.ortizcanavate@upm.es

### Brian G. Sims

FAO Agricultural Mechanization Consultant. 3 Bourneside Bedford MK41 7EG, U.K. BrianGSims@aol.com



E Gasparetto



W B Hoogmoed



Jan Pawlak



O S Marchenko



M Martinov



J Ortiz-Cañavate



Brian G Sims

### Retirement Co-editors' Name List

Co-editor's name	Nationality	Inaugural year	Retired year	Co-editor's name	Nationality	Inaugural year	Retired year
Adrian Moens	Netherlands	1972	1989	Wang Wanjun	China	1980	2012
Bala Krishna Shrestha	Nepal	1972	1991	Allan L. Phillips	U. S. A.	1981	2004
Chul Choo Lee	Korea	1972	2014	Julien G. Van Lancker	Brundi	1981	1989
Chau Van Khe	Vietnam	1972	1980	Suppiah Kathirkamathamby	Sri Lanka	1981	1991
Manbahadur Gurung	Bhutan	1972	2006	Armed Hossain Mirdha	Mexico	1982	1991
Merle L. Esmay	U. S. A.	1972	1990	A. A. Valenzuela	Chile	1982	2013
Giuseppe Pellizzi	Italy	1973	2012	David Boakye Ampratwum	Ghana	1982	2011
Mohamed A. Bedri	Sudan	1973	1987	Kshirode Chandra Roy	Bangladesh	1982	1985
Shahansha-Uddin Choudhury	Bangladesh	1973	1991	M. H. Abdel Aziz	Saudi Arabia	1982	1991
T. B. Muckle	U. K.	1973	1978	Krishna Prakash Srivastava	Ethiopia	1983	1989
Chang Joo Chung	Korea	1975	2014	Muhammad Siddique Chaudhry	U. S. A.	1983	1991
T. Tougaard Pedersen	Denmark	1975	1990	Wimala Tissa Weerakoon	Zambia	1983	1985
Bilash Kanti Bala	Bangladesh	1976	1982	Harry D. Henderson	Lebanon	1984	1985
George B. Hanna	Egypt	1976	1988	Mohammad Afzal	Pakistan	1984	1994
Jun Sakai	Japan	1976	2015	A. P. Kaloyanov	Bulgaria	1985	2013
Siswadi Soepardjo	Indonesia	1976	1985	Soedjatmiko	Indonesia	1986	2014
Mohammad Ilyas	Pakistan	1977	1981	Aalbert Anne Wanders	Netherlands	1988	2007
Amala Prasad Sharma	Fiji	1978	1981	Ali Mahmoud El Hossary	Egypt	1988	2010
Arumugam Kandiah	Ethiopia	1978	1989	Chanchai Rojanasaroj	Thailand	1988	2011
Bherulal T. Devrajani	Pakistan	1978	2004	Edward A. Baryeh	Zimbabwe	1988	2014
Satish Chandra	Fiji	1979	1990	Eltag S. Eldin Mahmoud	Sudan	1990	2011
Jitendra P. Mittal	Nigeria	1980	1993	Henrik Have	Denmark	1990	2009
Naresh Chandra Saxena	India	1980	1988	Graeme Ross Quick	Australia	1995	2015
Paris Andreou	Lebanon	1980	1984	Abdulsamad Abdulmalik Hazza'a	YEMEN	1999	2014

# TWO-WHEEL TRACTOR ENGINEERING for Asian Wet Land Farming

**by Jun Sakai**

**Professor emeritus of Kyushu University, Co-operating Editors of AMA**



A Present to the students who dream to be an international-minded specialist in farm machinery science & technology.

Introduction of new "Tractor-Tillage Engineering" based on a global view of agricultural civilizations in the world.

Two-wheel tractors contribute to the industrial promotion of agri-countries consisting of small-scale family farms.

The textbook with new guidelines for international technical cooperation with a better mutual understanding.

### CONTENTS

1. Difference between Euro-American and Asian farming civilizations
2. New wheel dynamics and tractor-vehicle engineering in the 21th century
3. New plowing science of walk-behind tractors originated from Asian paddy farming
4. Scientific creation and systematization of rotary tillage engineering in Asia

**English - Japanese Version**

Price: Japanese

Size: 21cm x 15cm, soft cover, 311 page

**Shin-Norinsha Co., Ltd.**

1-12-3 Kanda Nishikicho, Chiyoda-ku, Tokyo, Japan, Tel: +81-(0)3-3291-3671~4, Fax: +81-(0)3-3291-5717

E-mail: ama@shin-norin.co.jp URL: <http://www.shin-norin.co.jp>

◆ ◆ ◆  
**Vol.44, No.4, Autumn 2013**

**SUPECIAL ISSUE: THE THEME:**

*What kind of cooperation do you want from the Japanese government, agricultural industry, agricultural engineering associations, engineers, developers and researchers to promote agricultural mechanization in the developing countries and homeland?*

Anticipated Role of Japan Concerning Agricultural Mechanization Issues in Developing World (Alamgir Akhtar Khan, Ramesh P. Rudra).....	7
Which Plow is more Suitable for Tillage Farming in IRAQ? (Ali Mazin Abdul-Munaim).....	10
Agricultural Mechanization Strategy and Japan-Ghana Co-operation (Richard J. Bani, Selorm Y., Dorvlo).....	11
Far Sighted Decision (Bassam Snobar) .....	14
Role of Japan in Promotion of Agricultural Mechanization in INDIA (C. R. Mehta, R. K. Pajnoo).....	15
Promotion of Agricultural Mechanization? Case of INDIA (Indra Mani).....	18
Biogas Technology Transfer as an Important Factor of Rural Development (Jan Pawlak) 20	
Japanese Industry of Agricultural Machinery, R&D Institutions, Cooperation with Serbia (Milan Martinov).....	23
Promoting Agricultural Mechanization in Nigeria through the Intervention of Japanese Government (Oni, Kayode Carroll) .....	25
Successful Mechanization of Smallholder Agriculture? Opportunities for Cooperation and Partnership between Africa and Japan (Umezuruike Linus Opara) .....	27
Assistance in Promotion of Agricultural Mechanization in Developing Countries (Pavel Kic, Retta Zewdie) .....	31
What does this have to Do with Agricultural Engineers and this Magazine, AMA? (Graeme R. Quick) .....	34
Need of Public and Private Partnership for Sustainable Agriculture in Developing Countries (Surya Nath) .....	35
Industrialization and Tourism as Strategies for Promoting Agricultural and Fisheries Mechanization in the PHILIPPINES (Reynaldo M. Lantin).....	36
Agricultural Mechanization in Vietnam and How to Develop the Cooperation with Japan (Nguyen Hay) .....	41
National Modernization cannot be realized without the Development and Diffusion of Agricultural Mechanization (Jun Sakai).....	43
Global Problems in Agricultural Mechanization System of Russian Federation (O. S. Marchenko).....	45

□ □ □

Comparison Computerized Object Recognition Systems (E. Sert, Y. Pinar, D. Taskin, C. Taskin, N. Topcubasi).....	50
Design of a Mechanical Device to Applique	

the Direction of Cross-Section on Rural Road Projects (H. Ince).....	57
Predicting Tractor Power Requirements Using Decision Support System –A Tool For Farm Machinery Management (Vishal Bector, Surendra Singh, P. K. Gupta).....	63
Influence of Pad Configuration on Evaporative Cooling System Effectiveness inside a Wind Tunnel (M. A. Basiouny, Said Elshahat Abdallah) .....	70
Effects of Sowing Techniques and Seed Rates on Oilseed Rape Seedling Emergence, Crop Establishment and Grain Yield (M. A. Asoodar, Z. Yousefi) .....	82
Development of Tea Carding Machine for Chinese Green Tea (Li Bing, Xia Tao).....	87

◆ ◆ ◆  
**Vol.45, No.1, Winter 2014**

Up-Gradation and Improvement of Cotton Ginning Machinery (Muhammad Yasin, Alamgir Akhtar Khan, Masood A. Majeed Progressive Ginner).....	9
Performance Evaluation of Different Models of Power Weeders for Pulse Crop Cultivation (T. Senthilkumar, V. M. Duraisamy, D. Asokan) .....	15
Determination of the Suitability Period of S-3 Diesel Oil when Used in Tractor Engines (Ali Mazin Abdul-Munaim, Lutfi Hussain Md. Ali).....	20
Modification in Pantnagar Zero-Till Fertilizer Drill for Pulses (S. C. Sharma, V. S. Prasad, T. P. Singh).....	23
Fuel Properties of Denaturated Anhydrous and Aqueous Ethanol of Different Proofs (Manoj Kumar, T. K. Bhattacharya) .....	30
Effects of Different Tillage and Press Wheel Weight on Soil Cone Index and Dryland Wheat Yield in Khuzestan Iran (M. A. Asoodar, F. Mohajer Mazandarani) .....	35
Development and Evaluation of Seed Metering System for Water Soaked Cotton Seeds (Sushil Sharma, C. J. S. Pannu) .....	41
Development and Evaluation of Motorized Cowpea Thresher (F. A. Maunde).....	48
Does Chilling Water Increase Air Cooling Operation (Ali Mazin Abdul-Munaim, Samir B.Salman Al-Badri).....	53
Development and Performance Evaluation of Virgin Coconut Oil Cooker (A. C. Mathew, K. Madhavan, T. Arumuganathan) .....	56
Study on Sinkage and Rolling Resistance of Various Tractors in the Soil (Harvinder Singh Dhingra) .....	60
Mechanization of Cassava for Value Addition and Wealth Creation by the Rural Poor of Nigeria (K. C. Oni, O. A. Dyelade) .....	66
Effect of Exhaust Back Pressure on Noise Characteristic of Tractor Mufflers (Ashish Kr. Shrivastava, V. K. Tewari, Santosh K.) 79	
Optimizing Processing Parameters of Concentric type Rotary Sieve Grader using Dimensional Analysis (D. Balasubramanian) 84	

◆ ◆ ◆  
**Vol.45, No.2, Spring 2014**

Determination the Heat Performance for the Evaporative Cooling Pads (Samir B. Salman Al-Badri, M. H. Abdul-abass).....	7
Design and Development of a Hot Water Paddy Straw Pasteurizer for Mushroom Cultivation (Nanje Gowda N. A., G. Senthil Kumar).....	11
Processing Non-Conventional Forages via Baling Crop Residues (Abdoh, A. F., Said Elshahat Abdallah).....	19
Energy Requirement for Irrigation Pumps in Allahabad District, Uttar Pradesh (INDIA) (Sanjay Kumar, Chandra M. P.).....	26
Present Status of Agricultural Mechanization in Bangladesh (A. T. M. Ziauddin, Tasnia Zia) .....	30
Selection of Suitable Furrow Opener and Furrow Closer for Vegetable Transplanter (B. M. Nandede, H. Raheman, H. V. Deore).....	40
Performance Evaluation of Experimental Self-Propelled Double Row Sugarcane Harvester (Vaibhav Suryawanshi, Surinder Singh Thakur, Ankit Sharma) .....	48
Development and Evaluation of A New Double-Row Sugarcane Billet Planter with Overlap Planting Pattern (Moslem Namjoo, Jalil Razavi) .....	57
Development of a Mechanical Harvesting Aid for Prickly Pear Cactus Fruit (H. Ortiz-Laurel, D. Rössel-Kipping).....	65
The Effect of Tractor Load and Trafficking on Wheat Crop Yield (S. K. Patel, Indra Mani, A. P. Srivastava) .....	70
Design, Development and Evaluation of Self Propelled Garlic (Allium Sativum L.) Clove Planter (Brajesh Nare, Atul Kumar Shrivastava, Rajesh Kumar Naik, Apoorv Prakash) 74	
Drying of Dates Using Multiple Collectors Areas Followed by Equal Drying Areas in a Solar Tunnel Dryer (M. A. Basunia, H. H. Al-Handali, M. I. Al-Balushi) .....	80

◆ ◆ ◆  
**Vol.45, No.3, Summer 2014**

Development and Evaluation of Palmyrah Tree Climbing Device (K. Kathirvel, T. G. Kishore, D. Ananthkrishnan, C. Divaler Durairaj).....	7
Effect of Blade Width and Spading Frequency of Spading Machine on Specific Soil Resistance and Pulverisation (Ritu Dogra, Sewak Singh Ahuja, Baldev Dogra, Manjeet Singh Virk).....	12
Agricultural Mechanization Situation in the Palestinian Territories (Nawaf Abu-Khalaf, Yasser A. R. Natour) .....	18
Performance Evaluation of Motorized Ginger Rhizomes Splitting Machine (Simonyan, K. J., A. B. Eke, J. C. Adama, J. C. Ehiem, D. A. Okpara).....	22
Performance Evaluation of Paddy Straw Pasteurizer for Mushroom Cultivation (Nanje	

Gowda N. A., G. Senthil Kumaran, Meera Pandey).....	28
Axial Flow Pre-cleaner for on Farm Cleaning of Cotton (V. G. Arude, T. S. Manojkumar, S. K. Shukla).....	37
Response of an Engine to Biofuel Ethanol Blends (Prem. K. Sundaram, Jayant Singh, T. K. Bhattacharya, S. K. Patel).....	43
Development of an Image Analysis System for Sowing Machine Laboratory Tests (Bahattin Akdemir, Birol Kayisoglu, Bernard Benet) ..	49
Use of Queueing Theory to Organization of the Complex Rice Harvest-Transport on the Agroindustrial Rice Complex “Los Palacios” (Yanoy Morejón Mesa, Ciro E. Iglesias Coronel).....	56
Studies on Pre-Cooling of Tomato (T. Pandiarajan, A. Tajuddin).....	64
Effect of Coatings on Physical and Engineering Properties of Carrot ( <i>Daucus carota L.</i> ) Seeds in Relation to the Planter Design (Shiddanagouda Yadachi, Indra Mani, M. S. Kalra, Satish Lande, Cini Varghese).....	65
Mechanization Status of Saffron Production in Jammu & Kashmir State of India (Mudasir Ali, Shiv Kumar Lohan, Nehvi, F. A.).....	69
Design and Evaluation of Mango Stone Decorticator (T. V. Arun Kumar, V. Thirupathi, P. Rajkumar, R. Kasthuri, Lokesh).....	76
Design, Development and Testing of a Group Milk Feeder for Kids (Hem Chandra Joshi, Ram Govind, B. H. M. Patel).....	83
Development and Evaluation of Power Tiller Operated Zero Till-Drill for Mechanizing Wheat Sowing in Hills (D. K. Vatsa, Sukhbir Singh).....	86

◆ ◆ ◆  
**Vol.45, No.4, Autumn 2014**

Paddy Rice Production Mechanization in China —A Review (Lijun Xu, Minli Yang) 7	7
Development and Performance Evaluation of Two Row Subsoil Organic Mulch Cum Fertilizer Applicator (K. Kathirvel, R. Thiagarajan, D. Manohar Jesudas) .....	12
Studies on Utilization of Denatured Ethanol in Small Constant Speed Petrol Start Kerosene Run Type different Compression Ratio SI Engines (Manoj Kumar, T. K. Bhattacharya) .....	18
Reducing Draft Required for a Simple Chisel Tool (Saad Fathallah Ahmed, Abdalla M. Zein Eldin, S. M. Abdulaal) .....	26
Manufacture Evolution of a Microbial Contamination Detection Unit for Processed Tomatoes inside Food Factories (Wael Mohamed Elmessery, Said Elshahat Abdallah).....	32
Mechanization of Mulch Laying Process: —A Boon in Sustaining Global Agricultural Production (K. G. Singh, R. K. Sharda, R. P. Rudra, A. A. Khan) .....	39
Status, Challenges and Strategies for Farm Mechanization in India (C. R. Mehta, N. S. Chandel, T. Senthilkumar) .....	43
Human factors Intervention and Design Improvement of Manual Single row Conower for Gender Neutrality in Lowland Rice (M. Muthamil Selvan, S. Jacob K Annamalai, K. Kathirvel, S. Thambidurai) ....	51
Energy Budgeting of Sustainable Rice Based Cropping Systems in Sub Tropical India	

(V. P. Chaudhary, B. Gangwar, D. K. Pandey) .....	58
An Autogroover Machine for Making Helical Grooves on Rollers Used in Roller Ginning Machines (T. S. Manojkumar, V. G. Arude, S. K. Shukla) .....	69
Potential of Variable Rate Application Technology in India (Sushil Sharma, S. S. Manhas, R. M. Sharma, Shiv Kumar Lohan) ....	74
Studies on Development of Concentric Drum, Brush Type Ginger Peeler (E. Jayashree, R. Visvanathan) .....	82

◆ ◆ ◆  
**Vol.46, No.1, Winter 2015**

Development of a Self-Propelled Jute Seed Drill cum Rural Load Carrier (Narendra Singh Chandel, V.K. Tewari, Manish Kumara, Kirti Ranjan Jha).....	7
A Simple Portable Type Kiln for Bamboo Charcoal (K. K. Singh, Om Prakash, Anil Sood) .....	14
Metering Mechanism and Performance of a Torsional Vibration Meter (Ling Yang, Peixiang He, Mingjin Yang, Qingdong Li) 18	18
Design and Fabrication of Evaporative Cooling Transportation System (K. V. Vala, D. C. Joshi).....	22
Development and Evaluation of Carrot Harvester (Sunil Shirwal, Indra Mani, N P S Sirohi, Adarsh Kumar).....	28
Decision Support System for Estimating Operating Costs and Break-Even Units of Farm Machinery (Karan Singh, C. R. Mehta) .....	35
Biomass Conversion for Energy Carriers: An Analytical Review on Future Issues for Rural Applications in India (Anil Kumar Dubey, M. Muthamil Selvan, Murari Shyam) Development and Testing of Pedal Operated Wild Apricot Pit Grader (A. E. Kate, N. C. Shahi, U. C. Lohani, J. P. Pandey) .....	48
An Experimental Determination of the Specific Soil Resistance of a Sandy Loam Soil Using Vertical Soil Tillage in the North-east of Mexico (Campos-Magaña S. G., Cadena-Zapata M., Ramirez-Fuentes G., Pacheco-Lopez J. L., Reynolds-Chávez M. A., Valezuela-Garcia J. R.).....	53
Spatial Farm Power Usage Patterns in the State of Haryana, India (Dipankar De, Indra Mani, P. K. Sahoo) .....	58
Techno-Economic Appraisal for Strategic Planning of Rice Mechanization in Kerala, India (P. Shaji James, F. Mary Regina) .....	65
Research Project for State of Agricultural Machinery in Russian Federation (Oleg Marchenko).....	72

◆ ◆ ◆  
**Vol.46, No.2, Spring 2014**

Development and Evaluation of Zone-till with Subsurface Fertilizer Applicator for Unpuddled Transplanting Rice Cultivation (Khokan Kumer Sarker, Wang Xiaoyan, Li Hongwen, Xu Chunlin, Wu Jiaan, Qiao Xiaodong) .....	7
Determination of Spring Rigidity and Fruit Detachment force in Yomra Variety Hazelnut Trees (Ali Tekgöler, Taner Yildiz, H?seyin Sauk).....	13

Studies on Effectiveness of Electrostatic Spraying for Cotton Crop (Pramod Kumar Mishra, Manjeet Singh, Ankit Sharma, Karun Sharma, Amrit Kaur Mahal).....	17
Need of Ergonomically Mechanized Interventions in Selected Farm Operations in Hills of Himachal Pradesh (Sukhbir Singh, D. K. Vatsa).....	23
Design and Optimization of a Double-Concave Rocker Seedmeter for Precision Seeding (Jia Honglei, Zhao Jiale, Jiang Xinming, Guo Mingzhuo, Zhuang Jian, Qi Jiangtao, Yuan Hongfang) .....	29
Developing Countries in Africa and Priorities towards Implementation of Agricultural Mechanization (Retta Zewdie, Edwin Wallace, Pavel Kic).....	35
Status of Agricultural Mechanization in Lesotho (T. C. Lehlokoanyane, E. M. Chimbombi, M. Tapela, C. Patrick, R. Tsheko) ...	41
Effect of Deep Placement of Vermicompost and Inorganic Fertilizers in Subsoil at Different Depths on Mustard ( <i>Brassica juncea</i> ) Crop (J. P. Singh, T. C. Thakur, R. P. Singh).....	47
Optimization of an Industrial Type Prototype Shelf Dryer by Response Surface Methodology “A Case Study for Potato” (Nursel Heybeli, Can Ertekin, Davut Karayel).....	53
Effect of Long-Term Conservation Tillage on Soil Physical Properties and Soil Health under Rice-Wheat Cropping System in Sub Tropical India (V. P. Chaudhary, B. Gangwar, Shikha Gangwar) .....	61
Design and Experimental Evaluation of a Shearing Type Macadamia Nut Cracking Machine (Xue Zhong, Song Deqing, Deng Ganran) .....	74
Development and Evaluation of Open Top Biomass Gasifier for thermal Application (Atul Mohod, Y. P. Khandetod, S. H. Sengar, H. Y. Shrirame, P. B. Gadkari).....	77
Mechanized Mulching Practices with Plastic Film and Wheat Straw in Dryland Wheat Planting (Wenting Han, Pei Cao, Yu Sun, Gerong Dang, Shaoping Xue).....	82

■ ■



# INSTRUCTIONS TO AMA CONTRIBUTORS

The Editorial Staff of the AMA requests of articles for publication to observe the following editorial policy and guidelines in order to improve communication and to facilitate the editorial process:

## Criteria for Article Selection

Priority in the selection of article for publication is given to those that –

- a. are written in the English language;
- b. are relevant: to the promotion of agricultural mechanization, particularly for the developing countries;
- c. have not been previously published elsewhere, or, if previously published are supported by a copyright permission;
- d. deal with practical and adoptable innovations by, small farmers with a minimum of complicated formulas, theories and schematic diagrams;
- e. have a 50 to 100-word abstract, preferably preceding the main body of the article;
- f. are printed, double-spaced, under 3,000 words (approximately equivalent to 6 pages of AMA-size paper) ; and those that
- g. art: supported by authentic sources, reference or bibliography.
- h. written on CD-R.

## Rejected/Accepted Articles

- a. As a rule, articles that are not chosen for AMA publication are not returned unless the writer(s) asks for their return and are covered with adequate postage stamps. At the earliest time possible, the writer(s) is advised whether the article is rejected or accepted.
- b. When an article is accepted but requires revision/modification, the details will be indicated in the return reply from the AMA Chief Editor in which case such revision/modification must be completed and returned to AMA within three months from the date of receipt from the Editorial Staff.
- c. The AMA does not pay for articles published.
- d. Complimentary copies: Following the publishing, three successive issue are sent to the author(s).

## Procedure

- a. Articles for publication (original and one-copy) must be sent to AMA through the Co-operating Editor in the country where the article originates. (Please refer to the names and addresses of Co-operating Editors in any issue of the AMA). However, in the absence of any Co-operating Editor, the article needs to be sent to Co-operating Editor in the writer's neighboring country.
- b. Contributors of articles for the AMA for the first time are required to attach a passport size ID photograph (black and white print preferred) to the article. The same applies to those who have contributed articles three years earlier. In either case, ID photographs taken within the last 6 months are preferred.
- c. The article must bear the writer(s) name, title/designation, office/organization, nationality and complete mailing address.

## Format/Style Guidance

- a. Article must be sent on CD-R with MS DOS format (e.g. Word Perfect, Word for DOS, Word for Windows... **Absolutely necessary TEXT FORMAT**) along with two printed copy (A4).
- b. The data for graphs and photographs must be saved into piecemeal dates and enclosed with the article.
- c. Whether the article is a technical or popular contribution, lecture, research result, thesis or special report, the format must contain the following features:
  - (i) brief and appropriate title;
  - (ii) the writer(s) name, designation/title, office/organization; and mailing address;
  - (iii) an abstract following ii) above;
  - (iv) body proper (text/discussion);
  - (v) conclusion/recommendation; and a
  - (vi) bibliography
- d. The printed copy must be numbered (Arabic numeral) successively at the top center whereas the disc copy pages should not be number. Tables, graphs and diagrams must likewise be numbered. Table numbers must precede table titles, e.g., "Table 1. Rate of Seeding per Hectare". Such table number and title must be typed at the top center of the table. On the other hand, graphs, diagrams, maps and photographs are considered figures in which case the captions must be indicated below the figure and preceded by number, e.g., "Figure 1. View of the Farm Buildings".
- e. **The data for the graph must also be included. (e.g. EXCEL for Windows)**
- f. Tables and figures must be preceded by texts or discussions. Inclusion of such tables and figures not otherwise referred to in the text/discussion must be avoided.
- g. Tables must be typed clearly without vertical lines or partitions. Horizontal lines must be drawn only to contain the sub-title heads of columns and at the bottom of the table.
- h. Express measurements in the metric system and crop yields in metric tons per hectare (t/ha) and smaller units in kilogram or gram (kg/plot or g/row).
- i. Indicate by footnotes or legends any abbreviations or symbols used in tables or figures.
- j. Convert national currencies in US dollars and use the later consistently.
- k. Round off numbers, if possible, to one or two decimal units, e.g., 45.5 kg/ha instead of 45.4762 kg/ha.
- l. When numbers must start a sentence, such numbers must be written in words, e.g., Forty-five workers..., or Five tractors..."instead of 45 workers..., or, 5 tractors.



# SUBSCRIPTION/ORDER FORM

AGRICULTURAL MECHANIZATION IN ASIA, AFRICA AND LATIN AMERICA ( AMA )

Issued Quarterly

## AMA has Achieved an IMPACT FACTOR!!

AMA has been read by those involved in agricultural machinery and industry all over the world since the first publication in 1971. Thanks to many contributions from both the readers and writers, in 2012, we have achieved an Impact Factor, established by Thomson Reuters in U.S.A. AMA is the only Japanese agricultural machinery and industry related magazine which achieved an Impact Factor.

### Subscription Rate (includes surface mail postage)

Annual (4 issues)..... ¥ 8,000  
Single copy..... ¥ 2,500

(Check one)

- Please send me/us an invoice  
 I/We enclose remittance for ¥ \_\_\_\_\_  
 Please charge my/our credit card  
 VISA  
 MASTER Card. No. \_\_\_\_\_

Exp. date \_\_\_\_\_

Signature \_\_\_\_\_

We deeply appreciate your payment by credit card (NO EXTRA CHARGE NEEDED).  
We charge you extra 4,000 JPY when paid by check, and 6,000 JPY when paid by wire transfer.

\*\*\*\*\*

Name: \_\_\_\_\_

Firm: \_\_\_\_\_

Position: \_\_\_\_\_

Address: \_\_\_\_\_

(block letters)

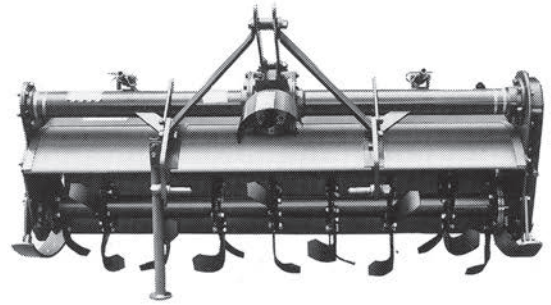
**FARM MACHINERY INDUSTRIAL RESEARCH CORP.**  
1-12-3 Kanda-Nishikicho, Chiyoda-ku, Tokyo 101-0054, Japan  
Tel. (03)-3291-3674  
URL: <http://www.shin-norin.co.jp>  
E-Mail: [ama@shin-norin.co.jp](mailto:ama@shin-norin.co.jp)



# AGRICULTURAL MACHINERY



We Look Forward To  
Extend Agribusiness  
With Global-Minded People.



Model: SX-1600NA (25 ~ 40HP)  
SX-1700NA

## Main Niplo Products

- ROTARY TILLER
- DRIVE HARROW
- FLAIL MOWER
- DEEP ROTARY TILLER
- DIGGER
- SEEDER

## MATSUYAMA PLOW MFG. CO., LTD.

Head Office & Factory

Head Office & Factory: 5155, Shiokawa, Ueda-shi, Nagano-ken, 386-0497, Japan

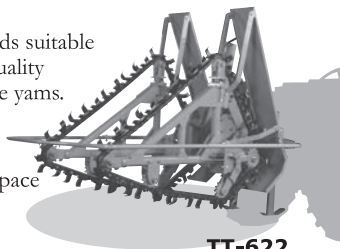
Telephone: +81-268-42-7504 Fax: +81-268-42-7528

**Kawabe trencher for tractors, making good cultivation beds for burdock and Chinese yams. Durable full-line structure for both general and exclusive use.**



### Chain Type

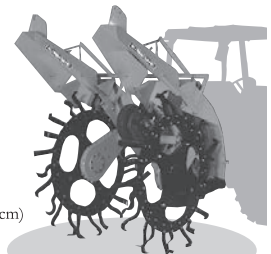
- Makes cultivation beds suitable for producing high quality burdock and Chinese yams.
- Full-line structure of 1, 2, and 4 row types.
- Adjustable interrow space from 60 to 132 cm. (2 row type)



TT-622

### Rotary Type

- Essential plowing performance as well as the Chain Type.
- Multiple furrow plow equipped. (single, double, and three furrow)
- Low horsepower and energy-saving structure with the ability of deep plowing. (maximum width: 18 cm / maximum depth: 120 cm)
- Double furrow type can adjust its interrow space between 90 and 120 cm (TDA-120).



RL-622

**Self-propelled general-purpose trencher, the basic needs for works in greenhouses, fields, and fruit farms.**

- By forward movement you can plow to replace surface soil with subsoil. By backward movement, you can dig wide trenches.
- Accomplish both bed making and harvest operation in one machine. Suitable for producing root vegetables.
- A high-performance and a compact structure every farmer, such as elderly and women, can easily handle.



NF-843

The Pioneer of Special Agricultural Machinery

**KAWABE NOKEN SANGYO CO., LTD**

HEAD OFFICE: 574-4 YANOGUCHI INAGI TOKYO 260-0812 JAPAN  
TEL: 042-377-5021 FAX: 042-377-8521  
URL <http://www.kawabenoken.co.jp>

